

BRAIDED WIRE PROTECTION

Lightweight Metallic and Non-Metallic Shielding
for Electrical Wire Interconnect Systems

EMI/RFI · ABRASION PROTECTION · GROUNDING

JANUARY 2017

ON THE COVER: In the back of a commuter jet, Dennis Roach and Ciji Nelson examine piezoelectric sensors placed on a printed circuit board for mounting to an aircraft structure. (Sandia National Laboratories Photo by Randy Montoya)

photo: Jetstar's first 787 on the production line



LIGHTWEIGHT Braided Wire Protection

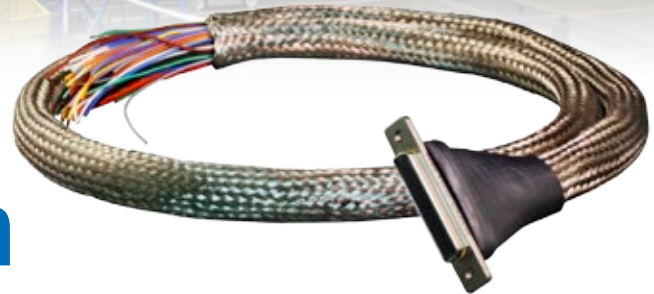

High-Performance Braided Shielding and Sleeving for EMI/RFI Screening and Mechanical Protection in Cable Assemblies

The world's most innovative line of metal, monofilament non-metallic, and microfilament composite and stainless steel braiding solutions for environmental, mechanical, and EMC shielding in interconnect cable assemblies

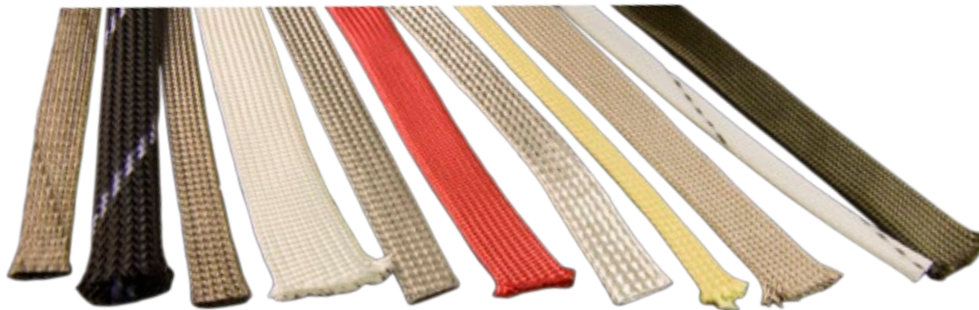

From high-temperature fiberglass tubular shielding for engine applications to ultra-lightweight EMI/RFI braided shielding for electrical wire interconnect grounding applications, Glenair offers the industry's most innovative range of solutions.

DuPont™ Nomex® and Kevlar® are trademarks or registered trademarks of E.I. duPont de Nemours and Company. All other referenced marks and brands are registered to, or possessions of, their respective owners and/or companies.

- Ultra lightweight solutions for weight-constrained applications such as aerospace and soldier systems
- A broad range of metallic and non-metallic material choices for every wire protection requirement
- Innovative microfilament braiding for 70% + weight reduction compared to standard QQB575 metal braids
- Innovative lightweight ground strap technologies
- New MasterWrap™ woven side-entry shielding
- Composite backshell/shield sock solutions

Braided Wire Protection

Lightweight Shielding Solutions for Electrical Wire Interconnect Systems



EMI/RFI Tubular Expandable Braided Shielding for EMC Applications

Lightweight ArmorLite™ and AmberStrand®
Industry-standard metallic braid

ARMORLITE™

AmberStrand®



A

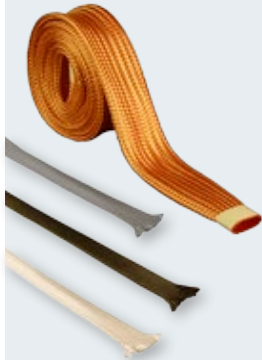

Non-Metallic Bulk Tubular Expandable Braid for wire harness protection

Monofilament and yarn braided shields incorporating PEEK · FEP · High-temperature PTFE · DuPont™ Nomex® · Ryton · Nylon · DuPont™ Kevlar®



B



MasterWrap™ Flexible Wraparound EMI/RFI Woven Sleeving and Other Special-Purpose Shielding Technologies

MasterWrap™ with ArmorLite™ · MasterWrap™ Nomex® · ArmorLite™ and Nomex® Spot-coverage tape wrap · Tapered tubular EMI/RFI braid



C



Integrated Shielding, Grounding, plus Band-Master® Braid Termination Solutions

Swing-Arm® 3-in-1 backshells with integrated shield socks · Braided ground straps · Piggyback boots · Band-Master ATS® · Heat Shrink Termination sleeves

SWING ARM®
COMPOSITE THREE-IN-ONE BACKSHELL

Band-Master ATS®

D



LIGHTWEIGHT, FLEXIBLE
EMI/RFI tubular expandable braided shielding
for EMC applications
material selection guide



Principal Selection Criteria	ARMORLITE Weight Reduction with Optimized Strength and Temperature Tolerance			AmberStrand® Weight Reduction		General-Duty				High Temperature plus Corrosion Resistance
Braid Part Number and Material Construction	 103-051 Microfilament ArmorLite™ 100% SS Nickel Plated	 103-052 Microfilament ArmorLite™ 75% SS/25% NiCu	 103-071 Microfilament ArmorLite™ 50% SS/50% NiCu	 103-026 Microfilament AmberStrand® 100% Nickel Plated	 103-027 Microfilament AmberStrand® 75% / 25% NiCu	 100-001 Soft Drawn Tin Plated Copper	 100-002 Soft Drawn Silver Plated Copper	 100-003 Soft Drawn Nickel Plated Copper	 100-005 Soft Drawn Tin Plated Copper-Clad Steel	 100-004 Soft Drawn Stainless Steel
RoHS Materials										
EMI Frequency Effectiveness Range	10 KHz to 1 GHz+	10 KHz to 1 GHz+	10 KHz to 1 GHz+	10 KHz to 1 GHz+	10 KHz to 1 GHz+	10 KHz to 1 GHz+	10 KHz to 1 GHz}+	10 KHz to 1 GHz+	Good (H Field) Poor (E Field)	Good (H Field) Poor (E Field)
Temperature Range	+260°C	+200°C	+200°C	+220°C	+200°C	+150°	+200°	+200°	+175°	+260°
Pull Strength*	150 Lbs. minimum	125 Lbs. minimum	125 Lbs. minimum	150 Lbs. minimum	125 Lbs. minimum	125 Lbs.	125 Lbs.	125 Lbs.	175 Lbs.	225 Lbs.
Corrosion Resistance Rating	500 Hours Salt Spray	500 Hours Salt Spray	500 Hours Salt Spray	500 Hours Salt Spray	500 Hours Salt Spray	48 Hours Salt Spray	48 Hours Salt Spray	500 Hours Salt Spray	96 Hours Salt Spray	1000 Hours Salt Spray
Abrasion Resistance	Good	Good	Good	Good	Good	Good	Fair	Good	Good	Very Good
Material Specification	ASTM A580	ASTM A580/ ASTM B355	ASTM A580/ ASTM B355	ZYLON AS	ZYLON AS ASTM B355	ASTM B33	ASTM B298	ASTM B355	ASTM B520	QQ-W-423/ ASTM A580

* Values are based on .500 Dia. Braid



INDUSTRY STANDARD · NON-METALLIC

Bulk tubular expandable braid for wire harness protection

non-metallic braid selection guide



Principal Selection Criteria	General Duty / Abrasion Resistance					Economy		Temperature Tolerance		Fire Resistance	
Braid Part Number and Material Construction	 102-060 Monofilament FEP	 102-001 · 102-002 Monofilament PET Type FR	 102-020 thru -023 Monofilament Halar®	 103-013 · 103-080 Yarn, Nomex®	 102-080 Monofilament Ryton Type R-7	 102-073 Yarn Dacron®	 102-072 Yarn Nylon	 102-051 Monofilament PEEK	 102-040 thru -043, 103-062, 103-106 Yarn Bonded and Unbonded, Nomex®	 100-022 Yarn PTFE-Glass	 102-071 Yarn, Kevlar®
Halogen-Free	NO		NO							NO	
Temperature Range	-55°C to +200°C	-55°C to +125°C	-65°C to +150°C	-55°C to +200°C	-65°C to +180°C	-62°C to +125°C	-20° to +170°	-65°C to +260°C	-60°C to +240°C	-204°C to +482°C	-73°C to +160°C
Tensile Strength (PSI) Yield	3300	50,000	7000	90,000	19,000	10,000	12,400	13,000	90,000	450,000	400,000
Elongation Percentage	50%	20%	15%	25%	40%	12%	20%	38%	25%	5%	3.6%
Chemical Resistance	Excellent	Good	Excellent	Excellent	Excellent	Good	Excellent	Excellent	Excellent (Unbonded) Outstanding (Bonded)	Excellent	Excellent
Abrasion Resistance	Good	Good	Excellent	Good	Excellent	Fair	Excellent	Excellent	Good (Unbonded) Excellent (Bonded)	Excellent	Good
Weight / Duty (specific gravity)	Heavy (2.17)	Medium (1.38)	Medium (1.68)	Medium (1.58)	Light (1.25)	Medium (1.38)	Light (1.14)	Light (1.3)	Medium (1.58)	Heavy (2.5)	Medium (1.44)
Flammability	Very Low	Flammable Self-Extinguishing	Very Low	Will Not Melt	Very Low	Flammable	Flammable	Very Low	Will Not Melt, Self-Extinguishing	Will Not Burn	Will Not Melt

* Values are based on .500 Dia. Braid. DuPont™ Nomex® and Kevlar® are trademarks or registered trademarks of E.I. duPont de Nemours and Company.

All other marks and brands are registered to, or possessions of, their respective owners and/or companies.

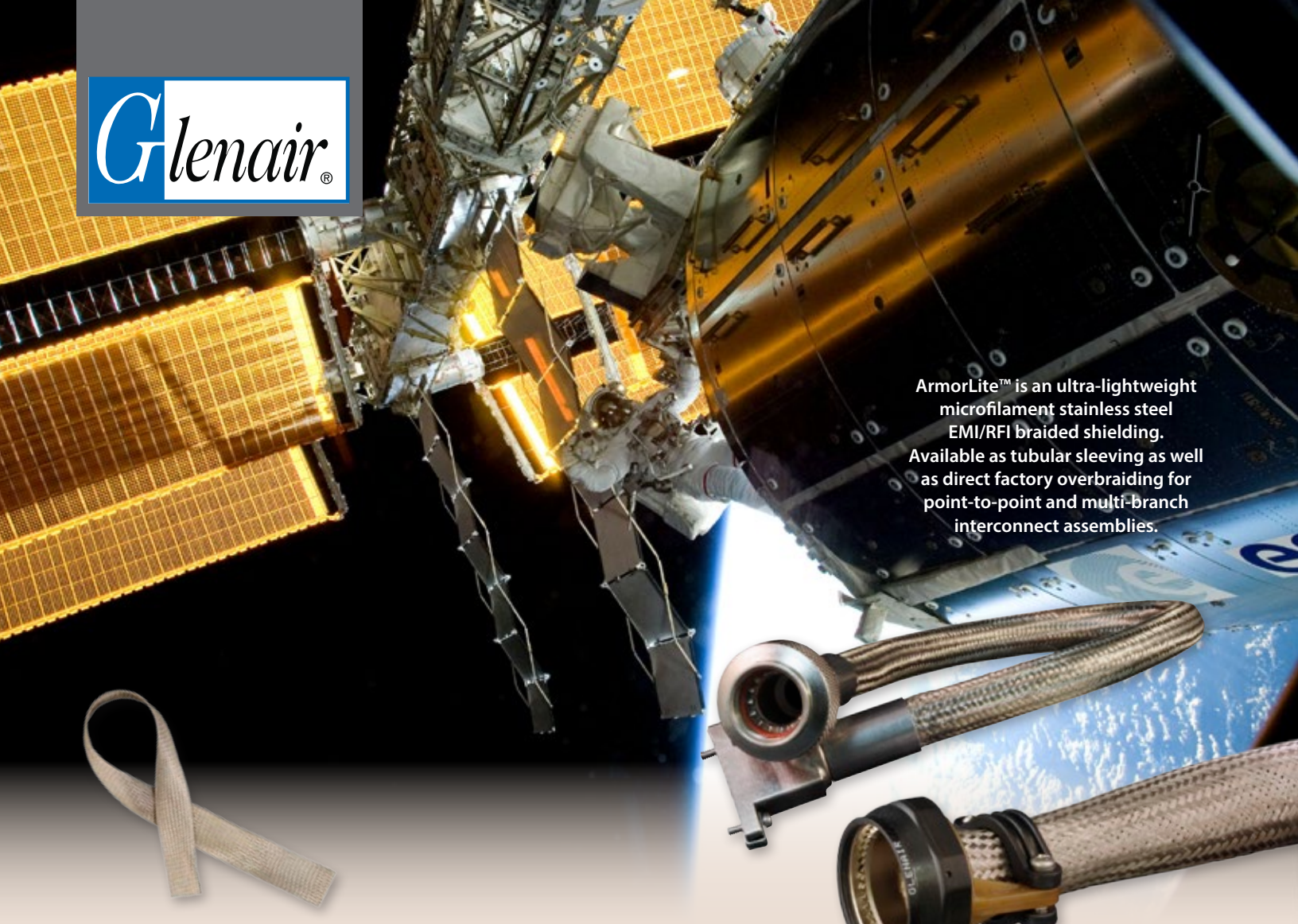

ArmorLite™ is an ultra-lightweight microfilament stainless steel EMI/RFI braided shielding. Available as tubular sleeving as well as direct factory overbraiding for point-to-point and multi-branch interconnect assemblies.



LIGHTWEIGHT

ARMORLITE™

Microfilament nickel-clad expandable stainless steel EMI/RFI braided shielding

Save weight and money every time you fly! All-Up-Weight (AUW) has met its match: ArmorLite™ microfilament stainless steel braid saves pounds compared to standard QQ-B-575/A-A-59569 EMI/RFI shielding. ArmorLite™ is an expandable, flexible, high-strength, conductive stainless steel microfilament braid material designed for use as EMI/RFI shielding in high-performance wire interconnect systems. The principal benefit of ArmorLite™ is its extreme light weight compared to conventional nickel/copper shielding. By way of comparison, 100 feet of 5/8 inch ArmorLite™ is more than four pounds lighter than standard 575 A-A-59569 shielding. Plus, ArmorLite™ offers superior temperature tolerance compared to other lightweight tubular braided shielding including microfilament composite technologies.

- Ultra-lightweight EMI/RFI braided sleeving for high-temperature applications -80°C to +260°C
- Microfilament stainless steel: 70% lighter than NiCu A-A-59569/QQB575
- Outstanding EMI/RFI shielding and conductivity
- Aerospace environment qualified
- Superior flexibility and “windowing” resistance: 90 to 95% optical coverage
- 70,000 psi (min.) tensile strength
- Best performing metallic braid during lightning tests (IAW ANSI/EIA-364-75-1997 Waveform 5B)

LIGHTWEIGHT, FLEXIBLE ArmorLite™ Microfilament Braid for EMI/RFI Shielding Applications



ArmorLite™ Performance Test Matrix			
DESCRIPTION	REQUIREMENT	PROCEDURE	REPORT
Altitude test 27,000 ft (5 PSIA nom.)	2.5% min.	RTCA DO-160F, Table 4-1, Table 4-2 Category C temp. spec	ARM-103
Operating Temperature	-80°C to +260°C	(Shielding effectiveness 1000 hours)	ARM-103
Braid Resistivity test, Pre and Post	Test pre/post-5 cycles-minimal disparity per spec.	EIA-364-32D IAW AS85049	ARM-110/1
Surface Transfer Impedance	Transfer Impedance (10.0 kHz ~ 1.0 GHz)	IEC 62153-4-3 min. 90% optical coverage	GT-17-263
Shield Effectiveness test, Pre and Post	Screening Attenuation (0 ~ 4.00 GHz)	IEC 62153-4-4 min. 90% optical coverage	GT-17-263
Tensile/ Pull Strength	220 lbs. (min.). No anomalies within 8% - 10% of pre test for variable sizes	Glenair ATP- 183. 0 lbs. to 90 lbs, to 150 lbs, to 220lbs @ speed of 0.25 inches/min	ARM-105
Specific Gravity Test	8.2 (max) per ISO-1183	ASTM A580 (ref 316L Stainless Steel)	ARM-109
Lightning Current Test	Glenair Qual. Test Plan 191/ DC resistance/ voltage criteria per DO-160F Level for 3 sizes up to 30Ka.	ANSI/EIA-364-75-1977 Wave Form 5B SAE/ARP5416 Section 6.3 Waveform 1, 3 (1, 10MHz) and 5A	ARM-110 ARM-112
Vertical Flammability	Self extinguishing ≤ 2 sec. Burn length 0.1 inch. max. Dripping 0.0 seconds.	14 CFR part 25.853 (a) AMdT25-116 Appendix F Part I (a) (1) (ii)	ARM-101
Mass Loss and Collected Volatile Condensable Materials	Total Mass Loss (TML) ≤1.0% Collected Volatile Condensable Matl.(CVCM) ≤.1%	ASTM E-595	ARM-102
Salt Spray Test	DC Resistance IAW AS85049 .5 milliohm. No evidence of base metal on braid	ASTM B117-09 Sodium Chloride 5% 500 hrs.	ARM-100
Vibration Resistance	EAI Test Report 33247. DO160 section 8 Cat. R Vib. Curves E1	DO-160F RTCA/DO-160F, Section 9, Fig. 8-4. Curve E1. - 3 sizes - 3 hours on each axis.	ARM-111
Thermal Shock Cycling test and Resistivity	No adverse effects in visual inspection or resistance after 50 cycles	EIA-364-32D, Table 3 Test condition V -65°C to +175°C	ARM-113
Abrasion and Plating test	DC Resistance IAW AS 85049. Glenair internal QTR-003	ATP 180 20 continuous @ 6 cycles/min. over 3 arms with .030 radiused edges	ARM-107
Fluid Immersion Test	Material compatibility – see table below	Customer/AS4373D method 601 Mod	ARM-106
Flex Test	2 Cycles: starting 0° over vertical ctr. line across to 180° cycle. Total cycles of 25633	Glenair ATP 179	ARM-112

ArmorLite™ Fluid Resistance Testing					
Test Fluid	Test Temp °C	Test Temp °F	Immersion Time(h)	Requirement	Procedure
MIL-L-23699, Lubricating Oil, Aircraft Turbine Engine, Synthetic Base	48-50	118-122	20	No fraying, DCResistance within limits (AS85049 paragraph 4.6.3)	SAE AS1241 Table 15/Mil-Std 810F Method 504 (modified), for all Substances. Additional conformance to Test Criteria AS4373D method 601 Mod
MIL-H-5606 (Inactive for New Design), Hydraulic Fluid, Petroleum Base, Aircraft Missile, and Ordnance	48-50	118-122	20		
TTI-I-735, Solvent, Isopropyl Alcohol	20-25	68-77	168		
ASTM D 1153, Methyl Isobutyl Ketone (For use in organic coatings)	20-25	68-77	168		
MIL-DTL-5624 , Turbine Fuel, Aviation, Grade JP-4 either or MIL-T-83133, JP-8	20-25	68-77	168		
SAE AMS1424, Anti-Icing and Deicing-Defrosting Fluid, undiluted	48-50	118-122	20		
SAE AMS1424, Anti-Icing and Deicing-Defrosting Fluid, diluted 60/40 (fluid/water) ratio. Supersedes Coolanol 25 Item Q	48-50	118-122	20		
MIL-C-43616, Cleaning Compound, Aircraft Surface	48-50	118-122	20		
SAE AS 1241 , Fire Resistant Hydraulic Fluid for Aircraft	48-50	118-122	20		
MIL-L-7808, Lubricating Oil, Aircraft Turbine Engine, Synthetic Base	118-121	244-250	30		
MIL-C-87937, Cleaning Compound, Aircraft Surface, Alkaline, undiluted	63-68	145-154	20		
MIL-C-87937, Cleaning Compound, Aircraft Surface, Alkaline Waterbase, diluted 25175 (fluid/water) ratio	63-68	145-154	20		
TT-S-735, Standard Test Fluids; Hydrocarbon, Type I	20-25	68-77	168		
TT-S-735, Standard Test Fluids; Hydrocarbon, Type II	20-25	68-77	168		
TT-S-735, Standard Test Fluids; Hydrocarbon, Type III	20-25	68-77	168		
TT-S-735, Standard Test Fluids; Hydrocarbon, Type VII	20-25	68-77	168		
MIL-PRF-87252, Coolant Fluid, Hydrolytically Stable, Dielectric	20-25	68-77	168		

LIGHTWEIGHT, FLEXIBLE

ArmorLite™ Microfilament Braid for EMI/RFI Shielding Applications



Aircraft utilization study

ARMORLITE™ AIRCRAFT UTILIZATION ANALYSIS

Comparison of ArmorLite® lightweight microfilament braid to standard A-A-59569 Ni/Cu braid



ArmorLite™ lightweight EMI/RFI braided shielding is ideally suited for weight reduction efforts in Electrical Wire Interconnect Systems in aerospace applications

Length and Weight of NiCu Braid in Typical Commercial Aircraft			
Diameter (in)	Weight (Lb/ft)	Length (in)	weight (Lb)
0 - 0.25	0.02	12564.8	21.08
0.25 - 0.5	0.05	5259.3	21.17
0.5 - 0.75	0.07	1212.6	7.12
0.75 - 1.0	0.14	1437.4	16.88
1.0 - 1.5	0.18	467	7.05
Total weight			73.3

Weight Savings Using ArmorLite™ (Equivalent Lengths)				
Diameter (in)	Weight (Lb/ft)	Length (in)	Length in feet	weight (Lb)
0 - 0.25	.00507	12564.8	1047.07	5.309
0.25 - 0.5	.0097	5259.3	438.28	4.251
0.5 - 0.75	.0178	1212.6	101.05	1.737
0.75 - 1.0	.0256	1437.4	119.78	3.063
1.0 - 1.5	.0368	467	38.92	1.434
Total weight				15.794



Using ArmorLite™ in place of standard nickel-copper braid saves 54.6 pounds per system—up to 78% weight savings!

Aircraft Zone Typical Braid Utilization (length in inches)								
L Wing	R Wing	Fwd Belly	Aft Belly	HYD Bay	Aft Barrel	Tail	V/H Stab	Totals
1852.2	1852.2	0	2811.4	168.2	2015.2	2480.6	1385	12564.8
434.8	434.8	511.6	1034.6	257.4	506.2	958.2	1121.7	5259.3
0	0	260.9	223	0	184.2	392.4	152.1	1212.6
0	0	77.2	0	0	1198	162.2	0	1437.4
0	0	0	0	0	446	21	0	467

LIGHTWEIGHT, FLEXIBLE ArmorLite™ Microfilament Braid



103-051 100% ArmorLite EMI/RFI microfilament stainless steel braided shielding



103-051 ARMORLITE™ LIGHTWEIGHT EMI/RFI MICROFILAMENT STAINLESS STEEL BRAIDED SHIELDING

How To Order				
Sample Part Number	103	-051	-024	-S
Product Code	Lightweight Braid Series			
ArmorLite™	-051 = 100% ArmorLite™ Nickel-Clad Stainless Steel			
Braid Diameter Dash Number	See Table			
Silver Clad Option	-S = silver clad Omit for standard nickel clad			

Dash Number - Diameter, Wire Bundle and Weight					
Dash No.	Nominal I.D. (ref.)	Wire Bundle Range (ref.)	Approx. Grams/Foot Nickel Clad	Approx. Grams/Foot Silver Clad	Approx. Milliohms/Meter
-001	.031 (.8)	.016 (.4) .047 (1.2)	.52	.53	355
-002	.062 (1.6)	.040 (1.0) .075 (1.9)	1.19	1.23	129
-004	.125 (3.2)	.093 (2.4) .140 (3.5)	1.55	1.60	109
-008	.250 (6.4)	.125 (3.2) .312 (7.9)	2.28	2.35	65
-012	.375 (9.5)	.250 (6.4) .406 (10.3)	3.00	3.10	49
-016	.500 (12.7)	.375 (9.5) .560 (14.2)	4.56	4.70	33
-020	.625 (15.9)	.375 (9.5) .700 (17.8)	4.97	5.13	32
-024	.750 (19.1)	.500 (12.7) .800 (20.3)	6.00	6.19	25
-032	1.000 (25.4)	.780 (19.8) 1.100 (27.9)	11.9	12.3	13
-040	1.250 (31.8)	.938 (23.8) 1.312 (33.3)	14.5	15.0	11.3
-048	1.500 (38.1)	1.187 (30.1) 1.590 (40.4)	17.9	18.5	9
-064	2.000 (50.8)	1.312 (33.3) 2.090 (53.1)	23.6	24.4	5

ArmorLite™ -051 vs. nickel-plated copper braid			
Braid Dia.	ArmorLite™ 103-051 grams per foot (approx.)	Nickel-Copper 100-003 grams per foot (approx.)	% Weight Savings/Foot
.031	.5	.9	44%
.062	1.2	1.9	37%
.125	1.6	4.8	67%
.250	2.3	16.1	86%
.375	3.0	18.5	84%
.500	4.6	22.3	79%
.625	5.0	27.7	82%
.750	6.0	34.3	83%
1.000	11.9	35.0	66%
1.250	14.5	44.0	67%
1.500	17.9	51.0	65%
2.000	23.6	60.0	61%



- 70+% weight savings over NiCu braid
- Outstanding EMI/RFI shielding and conductivity
- Broader temperature range: -80°C to +260°C
- Highly corrosion resistant
- Superior flexibility and "windowing" resistance

Transfer Impedance Comparison (Z_T) Size 16

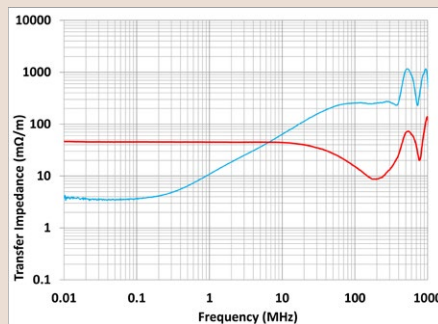

Screening Attenuation Comparison (A_3) Size 16

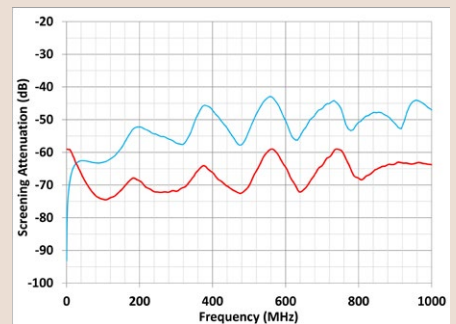

— 103-051-016 ArmorLite™ — 100-003A500 NiCu Tested per IEC 62153-4-3Ed2

NOTES

1. Material - ArmorLite™ nickel-clad 316L stainless steel. ArmorLite™ is a trademark of Glenair, Inc.
2. Specify length on purchase order. No minimums!

LIGHTWEIGHT, FLEXIBLE

ArmorLite™ Microfilament Braid



103-052 75% ArmorLite, 25% Nickel/Copper EMI/RFI microfilament stainless steel braided shielding

103-052 ARMORLITE™ LIGHTWEIGHT EMI/RFI MICROFILAMENT STAINLESS STEEL / NICKEL COPPER BRAIDED SHIELDING



How To Order				
Sample Part Number	103	-052	-024	-S
Product Code	Lightweight Braid Series			
ArmorLite™	-052 = 75% ArmorLite™ / 25% Nickel-Copper			
Braid Diameter Dash Number	See Table			
Silver Clad Option	-S = 75% ArmorLite / 25% silver-plated copper Omit for standard nickel clad			

ArmorLite™ -052 vs. nickel-plated copper braid			
Braid Dia.	ArmorLite™ 103-052 grams per foot (approx.)	Nickel-Copper 100-003 grams per foot (approx.)	% Weight Savings/ Foot
.062	1.6	1.9	16%
.125	1.8	4.8	63%
.250	2.8	16.1	83%
.375	3.5	18.5	81%
.500	5.4	22.3	76%
.625	5.7	27.7	79%
.750	7.5	34.3	78%
1.000	13.1	35.0	63%
1.250	15.8	44.0	65%
1.500	19.7	51.0	61%
2.000	24.4	60.0	59%

Dash Number - Diameter, Wire Bundle and Weight			
Dash No.	Nominal I.D. (ref.)	Wire Bundle Range (ref.)	Approx. Grams/Foot
-002	.062 (1.6)	.040 (1.0) – .075 (1.9)	1.6
-004	.125 (3.2)	.093 (2.4) – .140 (3.5)	1.8
-008	.250 (6.4)	.125 (3.2) – .312 (7.9)	2.8
-012	.375 (9.5)	.250 (6.4) – .406 (10.3)	3.5
-016	.500 (12.7)	.375 (9.5) – .560 (14.2)	5.4
-020	.625 (15.9)	.375 (9.5) – .700 (17.8)	5.7
-024	.750 (19.1)	.500 (12.7) – .800 (20.3)	7.5
-032	1.000 (25.4)	.780 (19.8) – 1.100 (27.9)	13.1
-040	1.250 (31.8)	.938 (23.8) – 1.312 (33.3)	15.8
-048	1.500 (38.1)	1.187 (30.1) – 1.590 (40.4)	19.7
-064	2.000 (50.8)	1.312 (33.3) – 2.090 (53.1)	24.4



- 70+% weight savings over NiCu braid
- Outstanding EMI/RFI shielding and conductivity
- Broader temperature range: -80°C to +200°C
- Highly corrosion resistant
- Superior flexibility and “windowing” resistance

Transfer Impedance Comparison (Z_T) Size 16

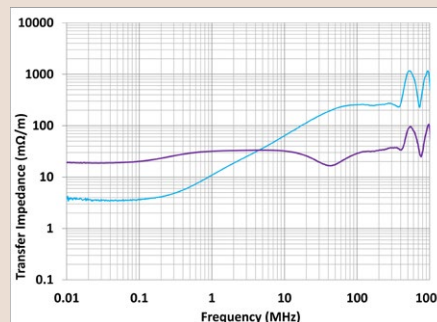

Screening Attenuation Comparison (A_S) Size 16

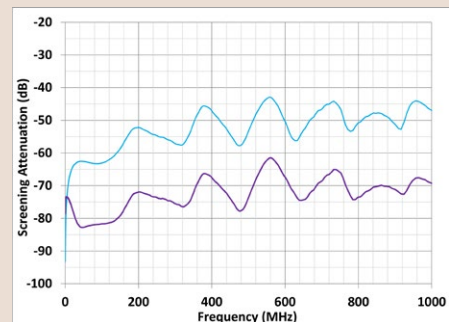

— 103-052-016 75% ArmorLite / 25% NiCu — 100-003A500 NiCu Tested per IEC 62153-4-3Ed2

NOTES

1. Material - 75% ArmorLite™ nickel-clad 316L stainless steel / 25% nickel plated copper.
S Option - 75% ArmorLite™ nickel-clad 316L stainless steel / 25% silver plated copper.
ArmorLite™ is a trademark of Glenair, Inc.
2. Specify length on purchase order. No minimums!

LIGHTWEIGHT, FLEXIBLE ArmorLite™ Microfilament Braid



103-071 50% ArmorLite, 50% Nickel/Copper EMI/RFI microfilament stainless steel braided shielding

103-071 ARMORLITE™ LIGHTWEIGHT EMI/RFI MICROFILAMENT STAINLESS STEEL / NICKEL COPPER BRAIDED SHIELDING



How To Order				
Sample Part Number	103	-071	-024	-S
Product Code	Lightweight Braid Series			
ArmorLite™	-071 = 50% ArmorLite™ / 50% Nickel-Copper			
Braid Diameter Dash Number	See Table			
Silver Clad Option	-S = 50% ArmorLite / 50% silver-plated copper Omit for standard nickel clad			



ArmorLite™ -071 vs. nickel-plated copper braid			
Braid Dia.	ArmorLite™ 103-071 grams per foot (approx.)	Nickel-Copper 100-003 grams per foot (approx.)	% Weight Savings/ Foot
.062	2.1	1.9	16%
.109	2.4	3.7	35%
.125	2.5	4.8	63%
.250	3.6	16.1	83%
.375	5.1	18.5	81%
.500	7.5	22.3	76%
.625	7.7	27.7	79%
.750	10.0	34.3	78%
1.000	15.5	35.0	63%
1.250	16.8	44.0	65%
1.500	27.9	51.0	61%
2.000	30.2	60.0	59%

Dash Number - Diameter, Wire Bundle and Weight			
Dash No.	Nominal I.D. (ref.)	Wire Bundle Range (ref.)	Approx. Grams/Foot
-001	.031 (0.8)	.025 (0.6) – .062 (1.6)	1.8
-002	.062 (1.6)	.040 (1.0) – .075 (1.9)	2.1
-003	.109 (2.8)	.075 (1.9) – .125 (3.2)	2.4
-004	.125 (3.2)	.093 (2.4) – .140 (3.5)	2.5
-008	.250 (6.4)	.125 (3.2) – .312 (7.9)	3.6
-012	.375 (9.5)	.250 (6.4) – .406 (10.3)	5.1
-016	.500 (12.7)	.375 (9.5) – .560 (14.2)	7.5
-020	.625 (15.9)	.375 (9.5) – .700 (17.8)	7.7
-024	.750 (19.1)	.500 (12.7) – .800 (20.3)	10.0
-032	1.000 (25.4)	.780 (19.8) – 1.100 (27.9)	15.5
-040	1.250 (31.8)	.938 (23.8) – 1.312 (33.3)	16.8
-048	1.500 (38.1)	1.187 (30.1) – 1.590 (40.4)	27.9
-064	2.000 (50.8)	1.312 (33.3) – 2.090 (53.1)	30.2



- 70+% weight savings over NiCu braid
- Outstanding EMI/RFI shielding and conductivity
- Broad temperature range: -80°C to +200°C
- Highly corrosion resistant
- Superior flexibility and “windowing” resistance

Transfer Impedance Comparison (Z_T) Size 16

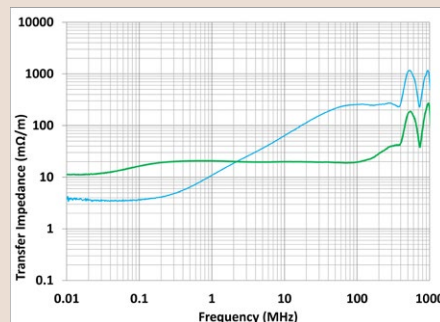

Screening Attenuation Comparison (A_S) Size 16

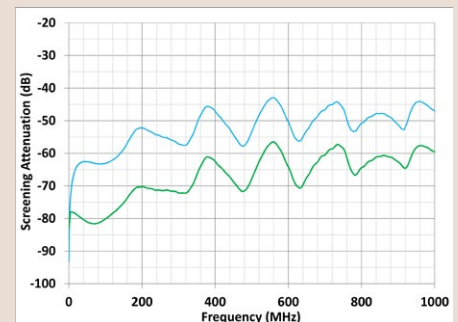

— 103-071-016 50% ArmorLite / 50% NiCu — 100-003A500 NiCu Tested per IEC 62153-4-3Ed2

NOTES

1. Material - 50% ArmorLite™ nickel-clad 316L stainless steel / 50% nickel plated copper.
S Option - 50% ArmorLite™ nickel-clad 316L stainless steel / 50% silver plated copper.
ArmorLite™ is a trademark of Glenair, Inc.
2. Specify length on purchase order. No minimums!

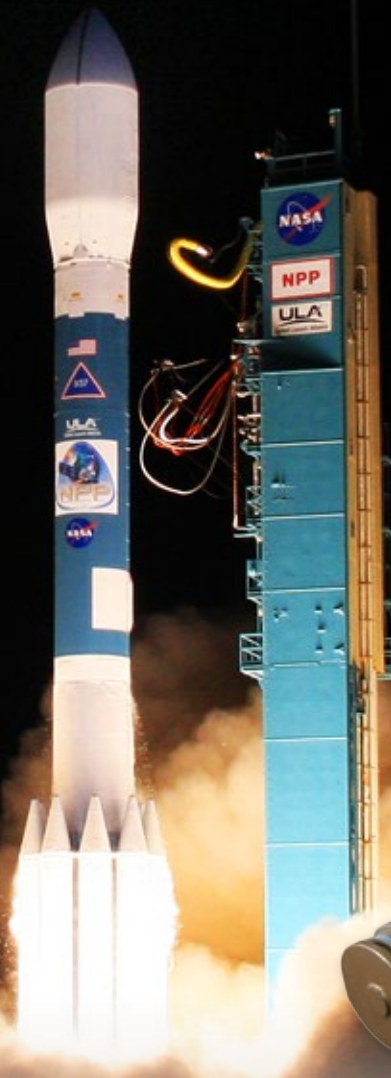

AmberStrand® is ultra-lightweight microfilament metal clad EMI/RFI composite braiding.

Glenair offers AmberStrand® users direct factory overbraiding services for point-to-point and multi-branch interconnect assemblies.



LIGHTWEIGHT

AmberStrand®

Composite metal-clad EMI/RFI expandable braided shielding

The smart way to reduce launch and flight weights in aerospace systems

For many applications, the cable shield is the most important element in controlling EMI. Unfortunately, metal shielding—especially when applied in multiple layers—can be extremely heavy. The opportunity to provide robust EMI shielding at a fraction of the weight is the principal advantage of composite thermoplastic EMI/RFI braid made from AmberStrand® material. Transfer impedance test reports demonstrate the effectiveness of the material compared to conventional metal solutions. So get smart! Reduce weight and save money with AmberStrand®

- Metal-clad EMI/RFI Shielding with a lightweight composite thermoplastic base material
- Highly conductive surface plating
- Reduce shielding weight up to 80% and more
- Reduce operation costs by permanently reducing launch and aircraft all-up weights
- Superior high frequency shielding compared to tinned and/or nickel plated copper
- Exceptional tensile strength: 590,000 psi (min)

LIGHTWEIGHT, FLEXIBLE



AmberStrand® Composite Braid for EMI/RFI Shielding Applications

The lightest weight EMI/RFI braid in the industry



103-026 AmberStrand® 100% Lightweight Composite Thermoplastic Nickel Plated EMI/RFI Braid		
Tensile Strength	590,000 psi (min)	ATP196 MOD
Operating Temperature	-80°C to +220°C	90% shielding effectiveness, 1000 hrs
Specific Gravity	1.45% (max)	ISO 1183
Thermal Cycling	No adverse effects in visual inspection or resistance after 50 cycles	-65°C to +200°C In accordance with ANSI/EIA-364-75-1997
Lightning Current	Glenair qualification test report 040607AMB	In accordance with ANSI/EIA-364-75-1997
Surface Transfer Impedance	Glenair qualification test report 040607AMB	IEC 96.1 A.5.5.3 method 2
Vertical Flammability	Self-extinguishing ≤ 2 sec. Burn length 0.1 in. max - Dripping 0.0 sec	14CFR part 25.853 (A) AMDT25-116 Appendix F Part I (a) (1) (ii)
Fungus Resistance Testing	28 day incubation test: No fungus growth	Mil-Std 810F, Method 508.5
Mass Loss And CVCM	1.0% max mass loss; .10% max CVCM	ASTM E595
Flex Test 50,000 Cycles	No tearing or visible damage	90° to 120° bend
Salt Spray 500 hrs.	DC Resistance IAW AS85049 .5 milliohms; no visible evidence of base metal on braid	ASTM B 117-03 Sodium Chloride 5%
Salt Fog SO ₂	No damage or adverse effects	ASTM G 85 Annex 4 200 hrs.
JP-8 (Mil-T-83133) Military Jet Aircraft Fuel (70°C)	No fraying, DC resistance within limits (AS85049 paragraph 4.6.3)	Mil-STD 810F Method 504 (Modified)
Skydrol Military Jet Aircraft Fuel (90°C)	No fraying, DC resistance within limits (AS85049 paragraph 4.6.3)	Mil-STD 810F Method 504 (Modified)
Hydraulic Fluid Mil-H-5606 (70°C)	No fraying, DC resistance within limits (AS85049 paragraph 4.6.3)	Mil-STD 810F Method 504 (Modified)
Silicate Ester Based Coolanol 25R (70°C)	No fraying, DC resistance within limits (AS85049 paragraph 4.6.3)	Mil-STD 810F Method 504 (Modified)
Polyalphaolefin Mil-C-87252 (70°C)	No fraying, DC resistance within limits (AS85049 paragraph 4.6.3)	Mil-STD 810F Method 504 (Modified)
Lubricating Oil Mil-L-23699 8 hrs. @ 150°C, followed by 72 hrs. @ 65°C	No fraying, DC resistance within limits (AS85049 paragraph 4.6.3)	Mil-STD 810F Method 504 (Modified)
Isopropyl Alcohol 8 hrs. @ 50°C followed by 72 hrs. @ 65°C	No fraying, DC resistance within limits (AS85049 paragraph 4.6.3)	Mil-STD 810F Method 504 (Modified)
Cleaner Fluid Mil-C-85570 8 hrs. @ 23°C followed by 72 hrs. @ 65°C	No fraying, DC resistance within limits (AS85049 paragraph 4.6.3)	Mil-STD 810F Method 504 (Modified)
De-icer Fluid AMS-1432 8 hrs. @ 23°C followed by 72 hrs. @ 65°C	No fraying, DC resistance within limits (AS85049 paragraph 4.6.3)	Mil-STD 810F Method 504 (Modified)
Fire Extinguishing foam 8 hrs. @ 23°C followed by 72 hrs. @ 65°C	No fraying, DC resistance within limits (AS85049 paragraph 4.6.3)	Mil-STD 810F Method 504 (Modified)
R-134 Refrigerant 8 hrs. @ 23°C followed by 72 hrs. @ 65°C	No fraying, DC resistance within limits (AS85049 paragraph 4.6.3)	Mil-STD 810F Method 504 (Modified)



AmberStrand® lightweight composite metal-clad microfilament braid is Glenair's lightest weight material for EMI/RFI shielding applications

LIGHTWEIGHT, FLEXIBLE

AmberStrand® Composite Braid



103-026 100% AmberStrand

EMI/RFI microfilament composite braided shielding

103-026 AMBERSTRAND® 100% COMPOSITE BRAID



AmberStrand®

- Electrically conductive
- Superior high-frequency shielding in high temperature applications
- Comparable shielding performance to 36 AWG tubular copper braid
- Lightweight, corrosion-free
- Weight savings up to 88% / foot compared to standard nickel-copper braid

How To Order				
Sample Part Number	103	-026	-008	S
Basic No.	Braided shielding			
AmberStrand®	-026 = 100% AmberStrand®			
Braid Diameter No.	See Table I			
Silver Clad Option	S = silver clad Omit for none			

AmberStrand 100% 103-026 - Diameter, Wire Bundle and Weight							
Dash No.	Nominal I.D. (ref.)	Wire Bundle Range (ref.)	Grams per Foot (approx.)	Dash No.	Nominal I.D. (ref.)	Wire Bundle Range (ref.)	Grams per Foot (approx.)
-001	.031 (.8)	.016 (.4) .047 (1.2)	0.4	-020	.625 (15.9)	.375 (9.5) .700 (17.8)	4.4
-002	.062 (1.6)	.040 (1.0) .075 (1.9)	0.6	-024	.750 (19.1)	.500 (12.7) .830 (21.1)	5.2
-004	.125 (3.2)	.093 (2.4) .140 (3.5)	1.0	-032	1.000 (25.4)	.780 (19.8) 1.100 (27.94)	8.0
-008	.250 (6.4)	.125 (3.2) .312 (7.9)	1.8	-040	1.250 (31.8)	.938 (23.8) 1.312 (33.3)	10.0
-012	.375 (9.5)	.325 (8.2) .437 (11.1)	2.3	-048	1.500 (38.1)	1.187 (30.1) 1.590 (40.37)	15.2
-016	.500 (12.7)	.375 (9.5) .560 (14.2)	3.7	-064	2.000 (50.8)	1.312 (33.3) 2.090 (53.08)	22.0

Transfer Impedance Comparison (Z_T) Size 16

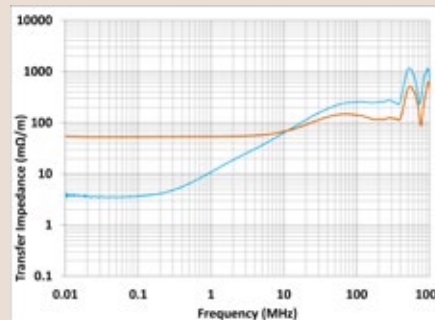

Screening Attenuation Comparison (A_s) Size 16

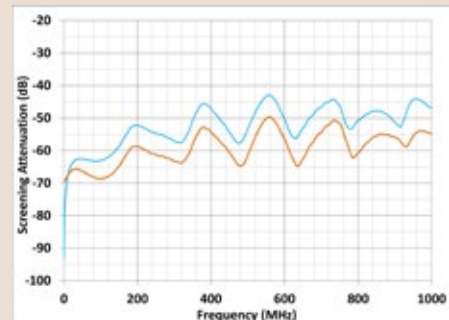

— 103-026-016 100% AmberStrand — 100-003A500 NiCu Tested per IEC 62153-4-3

AmberStrand® 100% vs. nickel-coated copper			
Braid Dia.	AmberStrand® 100% 103-026	Nickel-Copper 100-003	% Weight Savings/ Foot
.062	.6	1.9	68%
.125	1.0	4.8	79%
.250	1.8	16.1	88%
.375	2.3	18.5	87%
.500	3.7	22.3	83%
.625	4.4	27.7	84%
.750	5.2	34.3	85%
1.000	8.0	35.0	77%



100% AmberStrand® lightweight composite metal-clad microfilament braid is Glenair's lightest weight material for EMI/RFI shielding applications

NOTES

Material: Nickel- or silver-clad AmberStrand® composite fibers, amber color.
AmberStrand® is a registered trademark of Syscom Advanced Materials, Inc.

LIGHTWEIGHT, FLEXIBLE AmberStrand® Composite Braid



103-027 75% AmberStrand / 25% Nickel/Copper EMI/RFI microfilament composite braided shielding

103-027 AMBERSTRAND® 75%/25% BLENDED



- Electrically conductive
- Superior high-frequency shielding in high temperature applications
- Comparable shielding performance to 36 AWG tubular copper braid
- Lightweight, corrosion-free
- Weight savings up to 85% / foot compared to standard nickel-copper braid

How To Order				
Sample Part Number	103	-027	-008	S
Basic No.	Braided shielding			
AmberStrand®	-027 = 75% AmberStrand / 25% NiCu Blend			
Braid Diameter No.	See Table I			
Silver Clad Option	S = silver clad Omit for none			

AmberStrand 75% / NiCu 25% 103-027 - Diameter, Wire Bundle and Weight							
Dash No.	Nominal I.D. (ref.)	Wire Bundle Range (ref.)	Grams per Foot (approx.)	Dash No.	Nominal I.D. (ref.)	Wire Bundle Range (ref.)	Grams per Foot (approx.)
-001	.031 (.8)	.016 (.4) .047 (1.2)	0.6	-020	.625 (15.9)	.375 (9.5) .700 (17.8)	6.4
-002	.062 (1.6)	.040 (1.0) .075 (1.9)	0.9	-024	.750 (19.1)	.500 (12.7) .830 (21.1)	7.2
-004	.125 (3.2)	.093 (2.4) .140 (3.5)	1.5	-032	1.000 (25.4)	.780 (19.8) 1.100 (27.94)	11.0
-008	.250 (6.4)	.125 (3.2) .312 (7.9)	2.4	-040	1.250 (31.8)	.938 (23.8) 1.312 (33.3)	15.0
-012	.375 (9.5)	.250 (8.2) .437 (11.1)	3.9	-048	1.500 (38.1)	1.187 (30.1) 1.590 (40.37)	25.2
-016	.500 (12.7)	.375 (9.5) .550 (14.0)	6.0	-064	2.000 (50.8)	1.312 (33.3) 2.090 (53.08)	32.0

Transfer Impedance Comparison (Z_T) Size 16

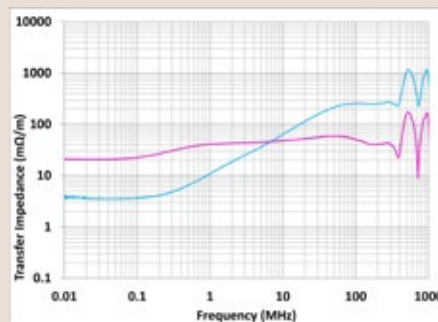

Screening Attenuation Comparison (A_s) Size 16

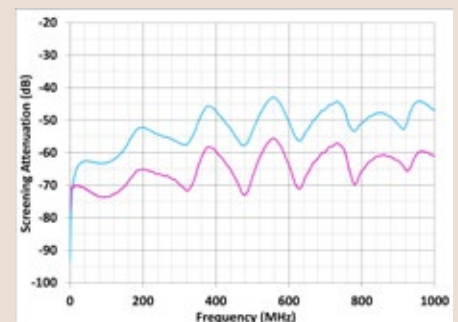

— 103-027-016 75% AmberStrand/25% NiCu — 100-003A500 NiCu Tested per IEC 62153-4-3

AmberStrand® 75% vs. nickel-coated copper			
Braid Dia.	AmberStrand® 75/25% NiCu 103-027	Nickel-Copper 100-003	% Weight Savings/ Foot
.062	.9	1.9	52%
.125	1.5	4.8	68%
.250	2.4	16.1	85%
.375	3.9	18.5	79%
.500	5.4	22.3	76%
.625	6.4	27.7	77%
.750	7.2	34.3	79%
1.000	11.0	35.0	69%



75% / 25% blended AmberStrand® is ideally suited for weight reduction applications that require additional braid strength and durability

NOTES

Material: Nickel- or silver-clad AmberStrand®, amber color, nickel plated copper wire/ASTM B355 CL 7 OFHC, 36 AWG

AmberStrand® is a registered trademark of Syscom Advanced Materials, Inc.

INDUSTRY-STANDARD METALLIC EMI/RFI Braided Shielding



100-001 tin-plated copper braid

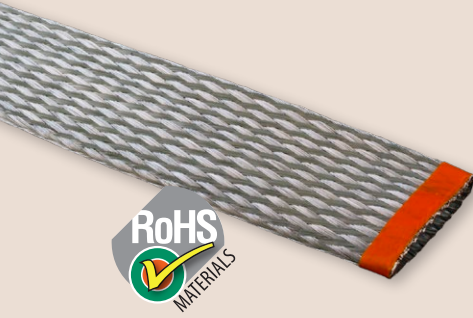

- Soft-drawn tin-plated copper braid
- EMI frequency effective from 10KHz to 1 GHz
- 150°C temperature tolerant
- 125 lbs. pull strength (.500 dia. braid)
- 48 hours salt spray corrosion resistant
- Good abrasion resistance



Industry-standard tin-plated copper braid is the workhorse material for EMI/RFI shielding in non-weight-sensitive military and commercial applications with a 10KHz to 1GHz effective range and good abrasion resistance.

100-001 TUBULAR METAL BRAID QQ-B-575B/A-A-59569 ASTM B33 DRAWN TIN PLATED COPPER

How To Order				
Sample Part Number	100-001	A	203	L
Basic No.	Tin/Copper Braid			
Wire Gage Code	A = 36 AWG D = 30 AWG B = 34 AWG E = 38 AWG C = 32 AWG F = 28 AWG (consult factory)			
Braid Diameter No.	See Tables I, II, III, IV, V			
Lanyard Option	L = with lanyard Omit = no lanyard			

Table I: 36 AWG					
Dash No.	Nominal I.D.	Carriers per Layer	Ends per Layer	Current Rating Amps	Lbs. per 100 ft.
031	.031 (0.8)	24	24	7.0	.20
062	.062 (1.6)	24	48	11.0	.40
078	.078 (2.0)	24	72	16.0	.60
109	.109 (2.8)	24	96	19.0	.83
125	.125 (3.2)	24	120	25.0	1.03
156	.156 (4.0)	24	240	40.0	2.09
171	.171 (4.3)	24	168	32.0	1.43
188	.188 (4.8)	24	192	33.0	1.63
203	.203 (5.2)	24	312	46.0	2.80
250	.250 (6.4)	24	384	53.0	3.45
281	.281 (7.1)	24	216	35.0	1.80
312	.312 (7.9)	48	288	42.0	2.58
375	.375 (9.5)	48	384	53.0	3.95
437	.437 (11.1)	48	432	56.0	4.22
500	.500 (12.7)	48	528	62.0	4.77
562	.562 (14.3)	48	624	73.0	5.00
625	.625 (15.9)	48	720	85.0	5.94
750	.750 (19.1)	48	816	86.0	6.69
781	.781 (19.8)	48	864	88.0	7.35
875	.875 (22.2)	64	640	75.0	5.44
937	.937 (23.8)	64	640	75.0	5.83
1000	1.000 (25.4)	64	768	90.0	7.50
1125	1.125 (28.6)	72	792	93.0	7.73
1250	1.250 (31.8)	72	792	93.0	7.73
1375	1.375 (34.9)	72	864	101.0	8.43
1500	1.500 (38.1)	72	936	110.0	9.13
1562	1.562 (39.7)	72	984	115.0	9.60
1750	1.750 (44.5)	96	1152	135.0	11.24
2000	2.000 (50.8)	96	1152	135.0	11.24
2300	2.300 (58.4)	96	1248	146.0	12.18
2500	2.500 (63.5)	96	1248	146.0	12.18
2750	2.750 (69.9)	96	1248	146.0	13.15
3375	3.375 (85.7)	96	1440	168.0	14.05

INDUSTRY-STANDARD METALLIC EMI/RFI Braided Shielding 100-001 tin-plated copper braid



A

Table II: 34 AWG					
Dash No.	Nominal I.D.	Carriers per Layer	Ends per Layer	Current Rating Amps	Lbs. per 100 ft.
062	.062 (1.6)	16	32	11.0	.43
109	.109 (2.8)	16	64	19.0	.82
125	.125 (3.2)	24	72	19.0	.92
171	.171 (4.3)	24	120	36.0	1.56
188	.188 (4.8)	24	120	36.0	1.56
203	.203 (5.2)	24	192	46.0	2.79
250	.250 (6.4)	24	192	46.0	2.47
375	.375 (9.5)	48	240	53.0	3.27
437	.437 (11.1)	48	288	57.0	3.93
500	.500 (12.7)	48	336	62.0	4.77
781	.781 (19.8)	48	528	88.0	7.14
1000	1.000 (25.4)	64	576	95.0	7.33
1125	1.125 (28.6)	72	648	108.0	8.44
1250	1.250 (31.8)	72	648	108.0	8.23
1500	1.500 (38.1)	72	720	120.0	9.14

Table III: 32 AWG					
Dash No.	Nominal I.D.	Carriers per Layer	Ends per Layer	Current Rating Amps	Lbs. per 100 ft.
062	.062 (1.6)	16	16	9.0	.32
109	.109 (2.8)	16	32	18.0	.63
125	.125 (3.2)	24	48	25.0	.95
171	.171 (4.3)	24	72	32.0	1.44
203	.203 (5.2)	24	120	46.0	2.38
250	.250 (6.4)	24	144	46.0	2.29
312	.312 (7.9)	24	144	46.0	2.86
375	.375 (9.5)	48	144	46.0	3.07
437	.437 (11.1)	24	240	90.0	4.76
500	.500 (12.7)	48	192	62.0	4.10
781	.781 (19.8)	48	336	88.0	7.17
1000	1.000 (25.4)	48	384	100.0	7.90

Table IV: 30 AWG					
Dash No.	Nominal I.D.	Carriers per Layer	Ends per Layer	Current Rating Amps	Lbs. per 100 ft.
281	.281 (7.1)	24	120	60.0	3.56
375	.375 (9.5)	24	168	75.0	5.30
437	.437 (11.1)	24	240	90.0	7.64
500	.500 (12.7)	24	360	120.0	11.46
562	.562 (14.3)	48	480	145.0	14.08
656	.656 (16.7)	48	768	190.0	23.22
781	.781 (19.8)	48	336	89.0	10.90
875	.875 (22.2)	48	336	100.0	10.28
1000	1.000 (25.4)	48	384	120.0	12.40
1125	1.125 (28.6)	48	432	130.0	13.72
1250	1.250 (31.8)	48	480	140.0	15.25
1375	1.375 (34.9)	48	528	150.0	16.77
1500	1.500 (38.1)	48	576	165.0	18.29
2000	2.000 (50.8)	48	672	180.0	21.34

Table V: 38 AWG					
Dash No.	Nominal I.D.	Carriers per Layer	Ends per Layer	Current Rating Amps	Lbs. per 100 ft.
125	.125 (3.2)	24	168	TBD	.88
171	.171 (4.3)	24	240	TBD	1.16
203	.203 (5.2)	24	312	TBD	1.65
250	.250 (6.4)	24	288	TBD	1.44
375	.375 (9.5)	48	480	TBD	2.52
500	.500 (12.7)	48	624	TBD	3.28
625	.625 (15.9)	48	720	TBD	3.75
937	.937 (23.8)	64	640	TBD	3.04

NOTES

1. Direct current ratings are given for information only. Values shown are for uninsulated braid in free air, at 30°C (86°F). Actual values will depend on permissible temperature rise, voltage drop and other conditions of service. Values should be de-rated if the braid is insulated or in close contact with other components.
2. Individual strands to be IAW ASTM-B33
3. Braid conforms to the requirements of A-A-59569
Copper/Tin Plate I.A.W ASTM B33
Lanyard - Synthetic fiber

INDUSTRY-STANDARD METALLIC EMI/RFI Braided Shielding



100-002 silver/copper braid



- Soft-drawn silver-plated copper braid
- EMI frequency effective from 10KHz to 1 GHz
- 200°C temperature tolerant
- 125 lbs. pull strength (.500 dia. braid)
- Good corrosion resistance



Industry-standard silver-plated copper braid is a special-purpose material for EMI/RFI shielding with improved high-temperature tolerance compared to standard tin-plated copper braid. Typically used for temperature applications above 150°C, the material also offers a shiny, bright surface appearance.

100-002 TUBULAR METAL BRAID QQ-B-575B/A-A-59569 ASTM B298 DRAWN SILVER PLATED COPPER

How To Order				
Sample Part Number	100-002	A	203	L
Basic No.	Silver/Copper Braid			
Wire Gage Code	A = 36 AWG B = 34 AWG (consult factory) D = 30 AWG (consult factory) E = 38 AWG (consult factory)			
Braid Diameter No.	See Tables I or II			
Lanyard Option	L = with lanyard Omit = no lanyard			

Table I: 36 AWG					
Dash No.	Nominal I.D.	Carriers per Layer	Ends per Layer	Current Rating Amps	Lbs. per 100 ft.
031	.031 (0.8)	24	24	7.0	.20
062	.062 (1.6)	24	48	11.0	.40
078	.078 (2.0)	24	72	16.0	.60
109	.109 (2.8)	24	96	19.0	.83
125	.125 (3.2)	24	120	25.0	1.03
156	.156 (4.0)	24	240	40.0	2.09
171	.171 (4.3)	24	168	32.0	1.43
188	.188 (4.8)	24	192	33.0	1.63
203	.203 (5.2)	24	312	46.0	2.80
250	.250 (6.4)	24	384	53.0	3.45
281	.281 (7.1)	24	216	35.0	1.80
375	.375 (9.5)	48	384	53.0	3.95
500	.500 (12.7)	48	528	62.0	4.77
625	.625 (15.9)	48	720	85.0	5.94
750	.750 (19.1)	48	864	88.0	7.35
781	.781 (19.8)	48	864	88.0	7.35
937	.937 (23.8)	64	640	65.0	5.83
1000	1.000 (25.4)	64	768	90.0	7.50
1250	1.250 (31.8)	72	792	93.0	7.73
1375	1.375 (34.9)	72	864	106.0	8.43
1500	1.500 (38.1)	72	936	110.0	9.13
2000	2.000 (50.8)	96	1152	135.0	11.24
2500	2.500 (63.5)	96	1248	146.0	12.18

Table II: 34 AWG					
Dash No.	Nominal I.D.	Carriers per Layer	Ends per Layer	Current Rating Amps	Lbs. per 100 ft.
062	.062 (1.6)	16	32	18.0	.43
109	.109 (2.8)	16	64	29.0	.82
125	.125 (3.2)	24	72	30.0	.92
171	.171 (4.3)	24	120	46.0	1.56
203	.203 (5.2)	24	192	59.0	2.79
250	.250 (6.4)	24	192	60.0	2.85
375	.375 (9.5)	48	240	69.0	3.27
437	.437 (11.1)	48	288	76.0	3.93
500	.500 (12.7)	48	336	82.0	4.77
781	.781 (19.8)	48	528	88.0	7.14
1000	1.000 (25.4)	64	576	95.0	7.33
1250	1.250 (31.8)	72	648	108.0	8.23

NOTES

1. Direct current ratings are given for information only. Values shown are for uninsulated braid in free air, at 30°C (86°F). Actual values will depend on permissible temperature rise, voltage drop and other conditions of service. Values should be de-rated if the braid is insulated or in close contact with other components.
2. Material/Finish:
Braid - Copper/Silver plated IAW QQ-B-575B, ASTM298 Class C
Lanyard - Synthetic fiber

INDUSTRY-STANDARD METALLIC EMI/RFI Braided Shielding 100-003 nickel/copper braid



100-003 TUBULAR METAL BRAID ASTM B355 CLASS 7 OFHC DRAWN NICKEL PLATED COPPER



How To Order				
Sample Part Number	100-003	A	203	L
Basic No.	Nickel/Copper Braid			
Wire Gage Code	A = 36 AWG B = 34 AWG C = 32 AWG (consult factory) D = 30 AWG (consult factory)			
Braid Diameter No.	See Tables I or II			
Lanyard Option	L = with lanyard Omit = no lanyard			



- Soft-drawn nickel-plated copper braid
- EMI frequency effective from 10KHz to 1 GHz
- 200°C temperature tolerant
- 125 lbs. pull strength (.500 dia. braid)
- 500 hours salt spray corrosion resistant



Highly conductive nickel-plated copper braid is preferred for its superior handling of temperature cycles above 150°C. Nickel plating is highly resistant to oxidation and will maintain an attractive appearance over time.

Table I: 36 AWG					
Dash No.	Nominal I.D.	Carriers per Layer	Ends per Layer	Current Rating Amps	Lbs. per 100 ft.
031	.031 (0.8)	24	24	7.0	.20
062	.062 (1.6)	24	48	11.0	.40
078	.078 (2.0)	24	72	16.0	.60
109	.109 (2.8)	24	96	19.0	.83
125	.125 (3.2)	24	120	25.0	1.03
156	.156 (4.0)	24	240	40.0	2.09
171	.171 (4.3)	24	168	32.0	1.43
188	.188 (4.8)	24	192	33.0	1.63
203	.203 (5.2)	24	312	46.0	2.80
250	.250 (6.4)	24	384	53.0	3.45
312	.312 (7.9)	48	288	42.0	2.58
375	.375 (9.5)	48	384	53.0	3.95
437	.437 (11.1)	48	432	57.0	4.28
500	.500 (12.7)	48	528	62.0	4.77
562	.562 (14.3)	48	624	73.0	5.00
625	.625 (15.9)	48	720	85.0	5.94
750	.750 (19.1)	48	768	87.0	6.47
781	.781 (19.8)	48	864	88.0	7.35
937	.937 (23.8)	64	640	65.0	5.83
1000	1.000 (25.4)	64	768	90.0	7.50
1125	1.125 (28.6)	72	792	93.0	7.73
1250	1.250 (31.8)	72	792	93.0	7.73
1375	1.375 (34.9)	72	864	101.0	8.43
1500	1.500 (38.1)	72	936	110.0	9.14
1562	1.562 (39.7)	72	984	115.0	9.60
2000	2.000 (50.8)	96	1152	135.0	13.15
2500	2.500 (63.5)	96	1248	146.0	14.25

Table II: 34 AWG					
Dash No.	Nominal I.D.	Carriers per Layer	Ends per Layer	Current Rating Amps	Lbs. per 100 ft.
062	.062 (1.6)	16	32	11.0	.43
109	.109 (2.8)	16	64	19.0	.82
125	.125 (3.2)	24	72	19.0	.92
156	.156 (4.0)	24	144	38.0	1.94
171	.171 (4.3)	24	120	36.0	1.56
203	.203 (5.2)	24	192	46.0	2.79
250	.250 (6.4)	24	192	46.0	2.79
375	.375 (9.5)	48	240	53.0	3.27
437	.437 (11.1)	48	288	44.2	3.93
500	.500 (12.7)	48	336	62.0	4.77
781	.781 (19.8)	48	528	88.0	7.14
1000	1.000 (25.4)	64	576	95.0	7.33
1250	1.250 (31.8)	72	648	108.0	8.23
1500	1.500 (38.1)	72	720	119.0	9.14
1750	1.750 (44.4)	72	864	143.0	10.92
2000	2.000 (50.8)	72	1008	167.0	12.80

NOTES

- Direct current ratings are given for information only. Values shown are for uninsulated braid in free air, at 30°C (86°F). Actual values will depend on permissible temperature rise, voltage drop and other conditions of service. Values should be de-rated if the braid is insulated or in close contact with other components.
- Material/Finish:
Braid - Copper/Nickel plated IAW ASTM B355 Class 7 OFHC
Lanyard - Synthetic fiber

INDUSTRY-STANDARD METALLIC EMI/RFI Braided Shielding

100-005 tin-plated copper-clad steel braid

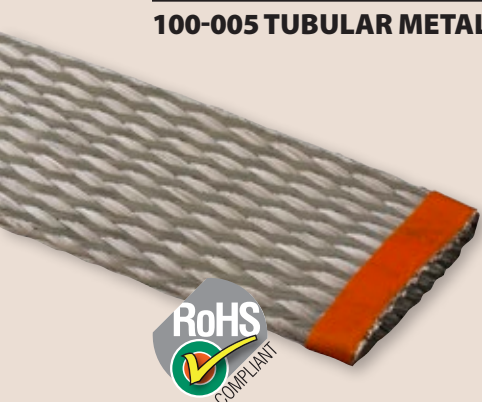

- Soft-drawn tin-plated copper-clad steel braid
- Good H Field EMI frequency effectiveness
- 175°C temperature tolerant
- 175 lbs. pull strength (.500 dia. braid)
- 96 hours salt spray corrosion resistant
- Good abrasion resistance



Multilaminar tin-plated copper-clad steel braid is an extremely versatile material. The steel core provides a strong, high tensile strength base for the more conductive copper cladding. Exterior tin plating prevents oxidation and corrosion.



100-005 TUBULAR METAL BRAID DRAWN TIN-PLATED COPPER-CLAD STEEL

How To Order				
Sample Part Number	100-005	A	203	L
Basic No.	Tin-plated copper-covered steel braid			
Wire Gage Code	A = 36 AWG B = 34 AWG			
Braid Diameter No.	See Tables I or II			
Lanyard Option	L = with lanyard Omit = no lanyard			

Table I: 36 AWG			
Dash No.	Nominal I.D.	Carriers per Layer	Ends per Layer
031	.031 (0.8)	24	24
062	.062 (1.6)	24	48
078	.078 (2.0)	24	72
109	.109 (2.8)	24	96
125	.125 (3.2)	24	120
156	.156 (4.0)	24	240
171	.171 (4.3)	24	168
188	.188 (4.8)	24	192
203	.203 (5.2)	24	312
250	.250 (6.4)	24	384
375	.375 (9.5)	48	384
500	.500 (12.7)	48	528
562	.562 (14.3)	48	624
625	.625 (15.9)	48	720
781	.781 (19.8)	48	864
937	.937 (23.8)	64	640
1000	1.000 (25.4)	64	768
1125	1.125 (28.6)	72	792
1250	1.250 (31.8)	72	792
1375	1.375 (34.9)	72	864
1500	1.500 (38.1)	72	936
2000	2.000 (50.8)	96	1152
2500	2.500 (63.5)	96	1248
3000	3.000 (76.2)	96	1440

Table II: 34 AWG			
Dash No.	Nominal I.D.	Carriers per Layer	Ends per Layer
062	.062 (1.6)	16	32
109	.109 (2.8)	16	64
125	.125 (3.2)	24	72
171	.171 (4.3)	24	120
203	.203 (5.2)	24	192
375	.375 (9.5)	48	240
437	.437 (11.1)	48	288
500	.500 (12.7)	48	336
781	.781 (19.8)	48	528
1000	1.000 (25.4)	64	576
1250	1.250 (31.8)	72	648
1500	1.500 (38.1)	72	720
1750	1.750 (44.4)	72	864
2000	2.000 (50.8)	72	1008

NOTES

1. Direct current ratings are given for information only. Values shown are for uninsulated braid in free air, at 30°C (86°F). Actual values will depend on permissible temperature rise, voltage drop and other conditions of service. Values should be de-rated if the braid is insulated or in close contact with other components.
2. For current rating and weight, consult factory
3. Material/Finish:
Braid - Tin-plated copper-covered steel ASTM B520
Lanyard - Synthetic fiber

INDUSTRY-STANDARD METALLIC EMI/RFI Braided Shielding

100-004 stainless steel braid



- Soft-drawn stainless steel braid
- Good H Field EMI frequency effectiveness
- 260°C temperature tolerant
- 225 lbs. pull strength (.500 dia. braid)
- 1000 hours salt spray corrosion resistant
- Abrasion resistant



ASTM A580 Stainless Steel braid is an extremely tough, flexible, and strong alternative to plated braiding solutions. The material is resistant to abrasion and will not rust or discolor over time. Ideally suited for both environmental and high-temperature applications that demand advanced corrosion protection.

100-004 TUBULAR METAL BRAID ASTM A580 DRAWN STAINLESS STEEL

How To Order				
Sample Part Number	100-004	A	203	L
Basic No.	Stainless Steel Braid			
Wire Gage Code	A = 36 AWG B = 34 AWG D = 30 AWG (Consult Factory)			
Braid Diameter No.	See Tables I or II			
Lanyard Option	L = with lanyard Omit = no lanyard			

Table I: 36 AWG					
Dash No.	Nominal I.D.	Carriers per Layer	Ends per Layer	Current Rating Amps	Lbs. per 100 ft.
031	0.031	24	24	1.2	0.18
062	0.062	24	48	1.8	0.36
078	0.078	24	72	2.4	0.56
109	0.109	24	96	2.9	0.77
125	0.125	24	120	3.4	0.93
156	0.156	24	240	5.3	1.83
171	0.171	24	168	4.2	1.29
188	0.188	24	192	4.6	1.51
203	0.203	24	312	6.4	2.45
219	0.219	24	192	4.6	1.54
250	0.250	24	384	7.3	3.14
312	0.312	48	288	6.0	2.26
375	0.375	48	384	7.3	3.09
500	0.500	48	528	9.0	4.30
562	0.562	48	624	10.0	5.06
625	0.625	48	720	11.0	5.98
781	0.781	48	864	12.5	7.31
937	0.937	64	640	10.2	5.73
1000	1.000	64	768	11.5	6.87
1125	1.125	72	792	11.8	6.92
1250	1.250	72	792	11.8	7.18
1375	1.375	72	864	12.5	8.03
1500	1.500	72	936	13.1	8.91
2000	2.000	96	1152	15.1	10.97
2500	2.500	96	1248	15.9	12.06

Table II: 34 AWG					
Dash No.	Nominal I.D.	Carriers per Layer	Ends per Layer	Current Rating Amps	Lbs. per 100 ft.
062	0.062	16	32	1.9	0.40
109	0.109	16	64	3.0	0.88
125	0.125	24	72	3.3	0.88
171	0.171	24	120	4.6	1.52
203	0.203	24	192	6.3	2.40
250	0.250	24	192	6.3	2.50
375	0.375	48	240	7.2	3.05
437	0.437	48	288	8.2	3.72
500	0.500	48	336	9.1	4.35
781	0.781	48	528	12.2	7.10
1000	1.000	64	576	12.9	8.34
1250	1.250	72	648	14.0	9.79
1500	1.500	72	720	15.0	10.88
1750	1.750	72	864	16.9	12.50
2000	2.000	72	1008	18.7	15.40

NOTES

1. Direct current ratings are given for information only. Values shown are for uninsulated braid in free air, at 30°C (86°F). Actual values will depend on permissible temperature rise, voltage drop and other conditions of service. Values should be de-rated if the braid is insulated or in close contact with other components.
2. Material/Finish:
Braid - Stainless Steel ASTM A580
Lanyard - Synthetic fiber

CORROSION-FREE, HIGH-TEMP, LIGHTWEIGHT, FLEXIBLE, ArmorLite™ CF Microfilament Braid



103-126 stainless steel over copper EMI/RFI microfilament braided shielding

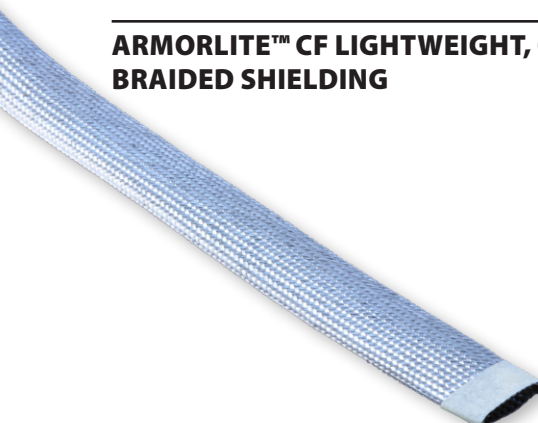

ARMORLITE™ CF LIGHTWEIGHT, CORROSION-FREE, TEMPERATURE-TOLERANT EMI/RFI BRAIDED SHIELDING

How To Order			
Sample Part Number	103	-126	-024
Product Code	Lightweight Braid Series		
ArmorLite™	-126 = ArmorLite™ CF		
Braid Diameter Dash Number	See Table		

ARMORLITE™ CF

- Broad temperature tolerance, -80°C to +400°C
- Corrosion / harsh environment resistant
- 1000 hour salt spray testing completed
- 70% reduced weight vs. standard braid
- Superb electrical resistance and shielding performance
- U.S. patent number US20200329594

Dash Number - Diameter, Wire Bundle and Weight			
Dash No.	Nominal I.D. (ref.)	Wire Bundle Range (ref.)	Approx. Grams/Foot
-001	.031 (0.8)	.016 (0.4) – .047 (1.2)	.6
-002	.062 (1.6)	.040 (1.0) – .075 (1.9)	1.5
-004	.125 (3.2)	.093 (2.4) – .140 (3.5)	1.8
-008	.250 (6.4)	.125 (3.2) – .312 (7.9)	2.8
-012	.375 (9.5)	.250 (6.4) – .406 (10.3)	3.8
-016	.500 (12.7)	.375 (9.5) – .560 (14.2)	5.5
-020	.625 (15.9)	.375 (9.5) – .700 (17.8)	5.8
-024	.750 (19.1)	.500 (12.7) – .800 (20.3)	7.7
-032	1.000 (25.4)	.780 (19.8) – 1.100 (27.9)	14.6
-040	1.250 (31.8)	.938 (23.8) – 1.312 (33.3)	16.4
-048	1.500 (38.1)	1.187 (30.1) – 1.590 (40.4)	21.0
-064	2.000 (50.8)	1.312 (33.3) – 2.090 (53.1)	29.0

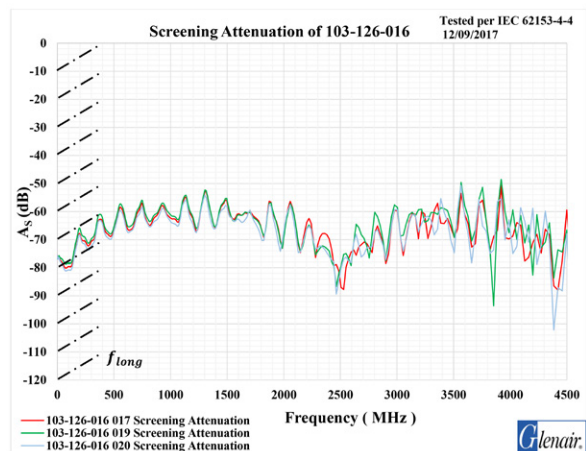
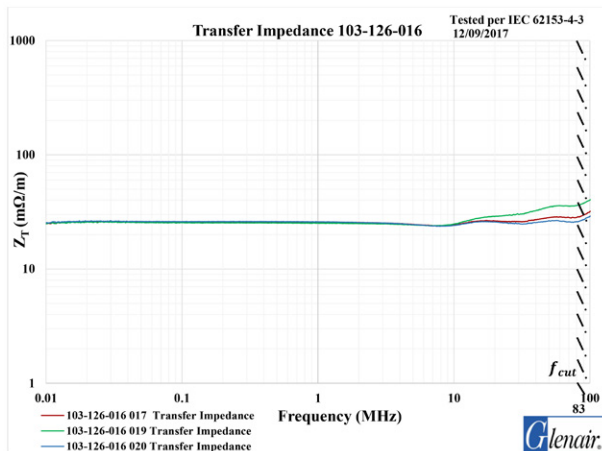







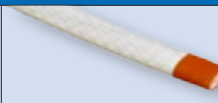

NOTES

1. Material - 316 stainless steel over copper microfilament braid
ArmorLite™ is a trademark of Glenair, Inc.
2. Specify length on purchase order. No minimums!

INDUSTRY STANDARD · NON-METALLIC
Bulk tubular expandable braid
for wire harness protection
 non-metallic braid selection guide



Principal Selection Criteria	General Duty / Abrasion Resistance				
Braid Part Number and Material Construction	 102-060 Monofilament FEP	 102-001 · 102-002 Monofilament PET Type FR	 102-020 thru -023 Monofilament Halar®	 103-013 · 103-080 Yarn, Nomex®	 102-080 Monofilament Ryton Type R-7
Halogen-Free	NO		NO		
Temperature Range	-55°C to +200°C	-55°C to +125°C	-65°C to +150°C	-55°C to +200°C	-65°C to +180°C
Tensile Strength (PSI) Yield	3300	50,000	7000	90,000	19,000
Elongation Percentage	50%	20%	15%	25%	40%
Chemical Resistance	Excellent	Good	Excellent	Excellent	Excellent
Abrasion Resistance	Good	Good	Excellent	Good	Excellent
Weight / Duty (specific gravity)	Heavy (2.17)	Medium (1.38)	Medium (1.68)	Medium (1.58)	Light (1.25)
Flammability	Very Low	Flammable Self-Extinguishing	Very Low	Will Not Melt	Very Low
Page Number	23	33	27	28 / 32	34

* Values are based on .500 Dia. Braid. DuPont™ Nomex® and Kevlar® are trademarks or registered trademarks of E.I. duPont de Nemours and Company.

INDUSTRY STANDARD · NON-METALLIC
Bulk tubular expandable braid
for wire harness protection
 non-metallic braid selection guide



Economy		Temperature Tolerance		Fire Resistance	
102-073	102-072	102-051	102-040 thru -043, 103-062,103-106	100-022	102-071
Yarn Dacron®	Yarn Nylon	Monofilament PEEK	Yarn Bonded and Unbonded, Nomex®	Yarn PTFE-Glass	Yarn, Kevlar®
				NO	
-62°C to +125°C	-20° to +170°	-65°C to +260°C	-60°C to +240°C	-204°C to +482°C	-73°C to +160°C
10,000	12,400	13,000	90,000	450,000	400,000
12%	20%	38%	25%	5%	3.6%
Good	Excellent	Excellent	Excellent (Unbonded) Outstanding (Bonded)	Excellent	Excellent
Fair	Excellent	Excellent	Good (Unbonded) Excellent (Bonded)	Excellent	Good
Medium (1.38)	Light (1.14)	Light (1.3)	Medium (1.58)	Heavy (2.5)	Medium (1.44)
Flammable	Flammable	Very Low	Will Not Melt , Self-Extinguishing	Will Not Burn	Will Not Melt
26	25	22	30, 31, 29	35	24

B

All other marks and brands are registered to, or possessions of, their respective owners and/or companies.

Bulk tubular non-metallic braid for wire harness protection

102-051 PEEK tubular braid



- Monofilament PEEK tubular braid
- -65° to +260°C temperature range
- 13,000 PSI yield tensile strength
- 38% elongation
- Excellent chemical resistance
- Excellent abrasion resistance

102-051 PEEK TUBULAR BRAID (BLACK)

How To Order		
Sample Part Number	102-051	-008
Basic No.	PEEK tubular braid (black)	
Braid Diameter No.	See Table I	

Table I			
Part No.	Nominal I.D.	Wire Bundle Accommodation Range Ref.	
		Min.	Max.
-004	.125 (3.2)	.125 (3.2)	.187 (4.7)
-008	.250 (6.4)	.250 (6.4)	.360 (9.1)
-012	.375 (9.5)	.312 (7.9)	.430 (10.9)
-016	.500 (12.7)	.375 (9.5)	.600 (15.2)
-024	.750 (19.1)	.500 (12.7)	.810 (20.6)
-040	1.250 (31.8)	.750 (19.1)	1.312 (33.3)
-064	2.000 (50.8)	.937 (23.8)	2.187 (55.5)
-080	2.500 (63.5)	1.125 (28.6)	2.687 (68.2)



Polyether ether ketone (PEEK) is a popular composite thermoplastic material with outstanding high-temperature resistance, crush resistance, and flexibility. PEEK is typically specified in applications that require optimized weight reduction as well as abrasion resistance and zero halogen content.

NOTES

1. Material - Polyether ether ketone (PEEK) black. Operating temperature -70°C to +260°C

BRAIDED WIRE PROTECTION

Bulk tubular non-metallic braid for wire harness protection



102-060 FEP tubular braid



102-060 CLEAR FEP MONOFILAMENT TUBULAR BRAID

How To Order		
Sample Part Number	102-060	-008
Basic No.	Clear FEP monofilament braid	
Braid Diameter No.	See Table I	



- Monofilament FEP tubular braid
- -55° to +200°C temperature range
- 3,300 PSI yield tensile strength
- 50% elongation
- Excellent chemical resistance
- Good abrasion resistance
- Very low flammability

Dash No.	Nominal I.D.	Wire Bundle Accommodation Range Ref.	
		Min.	Max.
004	.125 (3.2)	.090 (2.3)	.250 (6.4)
008	.250 (6.4)	.125 (3.2)	.375 (9.5)
012	.375 (9.5)	.312 (7.9)	.430 (10.9)
016	.500 (12.7)	.250 (6.4)	.750 (19.1)
024	.750 (19.1)	.500 (12.7)	1.250 (31.8)
040	1.250 (31.8)	.750 (19.1)	1.500 (38.1)



FEP tubular braid is one of many non-metallic material choices available from Glenair selected for its high lubricity, and as a result its excellent resistance to abrasion. FEP is a high temperature material well-suited for both military and commercial transport applications. This clear variant of the FEP material is typically specified for systems where a clean appearance and/or the ability to visually inspect sub-material layers is valued.

NOTES

1. Material - monofilament (FEP) clear.
2. Temperature range -55°C to +200°C
3. Minimum order length is 100 ft. (30.5m)



Bulk tubular non-metallic braid for wire harness protection

102-071 tubular braid, Kevlar®



102-071 TUBULAR BRAID, KEVLAR® (NATURAL OR BLACK)



Natural



B
Black



- Yarn, duPont™ Kevlar® tubular braid
- -73° to +160°C temperature range
- 400,000 PSI yield tensile strength
- 3.6% elongation
- Excellent chemical resistance
- Good abrasion resistance
- Fire-resistant, will not melt

How To Order			
Sample Part Number	102-071	-008	B
Basic No.	Tubular braid, Kevlar®		
Braid Diameter No.	See Table I		
Color option	B = Black Omit for Natural		

Part No.	Nominal I.D.	Wire Bundle Accommodation Range Ref.	
		Min.	Max.
-004	.125 (3.2)	.090 (2.3)	.250 (6.4)
-008	.250 (6.4)	.125 (3.2)	.375 (9.5)
-012	.375 (9.5)	.312 (7.9)	.500 (12.7)
-016	.500 (12.7)	.250 (6.4)	.750 (19.1)
-024	.750 (19.1)	.500 (12.7)	1.250 (31.8)
-032	1.250 (31.8)	.625 (15.9)	1.375 (34.9)
-040	1.250 (31.8)	.750 (19.1)	1.500 (38.1)
-064	2.000 (50.8)	1.375 (34.9)	2.500 (63.5)



Non-metallic tubular braid, Kevlar®, earns much of its reputation for strength and abrasion resistance due to its construction from individual strands of yarn (as opposed to monofilament materials such as FEP and PEEK). 102-071 is Glenair's strongest non-metallic tubular braid material, and offers excellent resistance to caustic chemicals and fluids as well as wire interconnect protection at temperatures up to 160°C.

NOTES

1. Material - DuPont™ Kevlar®, natural or black. DuPont™ and Kevlar® are trademarks or registered trademarks of E.I. duPont de Nemours and Company.
2. Minimum order length is 100 ft. (30.5m)

BRAIDED WIRE PROTECTION

Bulk tubular non-metallic braid for wire harness protection

102-072 Nylon tubular braid



102-072 NYLON TUBULAR BRAID (BLACK)



G
Gray

Standard
Black

How To Order			
Sample Part Number	102-072	-008	G
Basic No.	Nylon tubular braid		
Braid Diameter No.	See Table I		
Color option	G = Gray Omit for standard black		

Table I			
Part No.	Nominal I.D.	Wire Bundle Accommodation Range Ref.	
		Min.	Max.
-004	.125 (3.2)	.090 (2.3)	.250 (6.4)
-008	.250 (6.4)	.125 (3.2)	.375 (9.5)
-012	.375 (9.5)	.312 (7.9)	.500 (12.7)
-016	.500 (12.7)	.250 (6.4)	.750 (19.1)
-024	.750 (19.1)	.500 (12.7)	1.250 (31.8)
-040	1.250 (31.8)	.750 (19.1)	1.500 (38.1)



- Multifilament Nylon tubular braid
- -20° to +170°C temperature range
- 12,400 PSI yield tensile strength
- 20% elongation
- Excellent chemical resistance
- Excellent abrasion resistance



Multifilament Nylon is the workhorse of non-metallic tubular braid used for electrical wire interconnect system protection. It offers excellent abrasion resistance, general-duty resistance to fuels and chemicals, and is available in standard black or gray for identification of wire bundles. Nylon is an economical choice for most general-purpose applications.

NOTES

1. Material - Nylon per MIL-C-572 type P form Y
2. Minimum order length is 100 ft. (30.5m)

Bulk tubular non-metallic braid for wire harness protection



102-073 Black Dacron® tubular braid per MIL-C-572G

102-073 DACRON® TUBULAR BRAID (BLACK)



- Yarn Dacron® tubular braid
- -62° to +150°C temperature range
- 10,000 PSI yield tensile strength
- 12% elongation
- Good chemical resistance
- Good abrasion resistance
- Fire-resistant, will not melt

How To Order		
Sample Part Number	102-073	-008
Basic No.	Dacron® tubular braid (black)	
Braid Diameter No.	See Table I	

Table I			
Dash No.	Nominal I.D.	Wire Bundle Accomodation Range Ref.	
		Min.	Max.
-004	.125 (3.2)	.090 (2.3)	.250 (6.4)
-008	.250 (6.4)	.125 (3.2)	.375 (9.5)
-012	.375 (9.5)	.312 (7.9)	.500 (12.7)
-016	.500 (12.7)	.250 (6.4)	.750 (19.1)
-024	.750 (19.1)	.500 (12.7)	1.250 (31.8)
-040	1.250 (31.8)	.750 (19.1)	1.500 (38.1)



Dacron® is similarly constructed to Glenair's 102-071 material. It is a multistrand yarn construction tubular braid with excellent tensile strength, durability and chemical resistance, albeit at a lower performance level compared to the costlier Kevlar.

NOTES

1. Material - Dacron® polyester per MIL-C-572G type PSTR forms C and Y
color - Black

BRAIDED WIRE PROTECTION

Bulk tubular non-metallic braid for wire harness protection

102-020, -021, -022, and -023 expandable Halar®



102-020, -021, -022 AND -023 HALAR® EXPANDABLE NON-METALLIC TUBULAR BRAIDED SLEEVING



102-020
White with black tracer

102-021
Black

102-022
Black with white tracer

102-023
White

How To Order			
Sample Part Number	102-021	-008	-645
Basic No.	102-020 White with black tracer 102-021 Black 102-022 Black with white tracer 102-023 White		
Braid Diameter No.	See Table I		
Split braid option	-645 add mod code for split braid		

Table I						
Dash No.	Nominal I.D.	Ref. wire bundle range		Material Dia.	Wall Thickness Nominal	Spec max weight lbs. / 100 ft. [Kg/30.5m]
		Min	Max			
-004	.125 (3.2)	.090 (0.25)	.250 (6.4)	.011 (0.28)	.030 (0.8)	.29 (0.13)
-008	.250 (6.4)	.125 (0.25)	.375 (9.5)			.39 (0.18)
-012	.375 (9.5)	.250 (6.4)	.625 (15.9)			
-016	.500 (12.7)	.250 (6.4)	.750 (19.1)			1.17 (0.53)
-020	.625 (15.9)	.375 (9.5)	1.000 (25.4)			1.50 (0.68)
-024	.750 (19.1)	.500 (12.7)	1.250 (31.8)			1.81 (0.82)
-032	1.000 (25.4)	.625 (15.9)	1.375 (34.9)			
-040	1.250 (31.8)	.750 (19.1)	1.500 (38.1)			2.56 (1.16)
-048	1.500 (38.1)	.781 (19.8)	1.750 (44.5)			
-064	2.000 (50.8)	.937 (23.8)	2.125 (54.0)			

B



- Monofilament Halar® tubular braid
- -65° to +150°C temperature range
- 7,000 PSI yield tensile strength
- 15% elongation
- Excellent chemical resistance
- Excellent abrasion resistance
- Very low flammability



Halar® is a self-extinguishing tubular braided sleeving used for mid-range temperature applications. Halar® is chemically resistant to corrosive liquids including organic solvents, and has been successfully applied to applications from nuclear power plants to premise wire interconnect protection systems.

NOTES

1. Material - Halar®
2. Maximum operating temperature +150°C
3. Minimum order length is 100 ft. (30.5m)

Bulk tubular non-metallic braid for wire harness protection

102-101 Ceramic tubular braid (Nextel™ 312)



102-101 CERAMIC TUBULAR BRAID (NEXTEL™ 312)

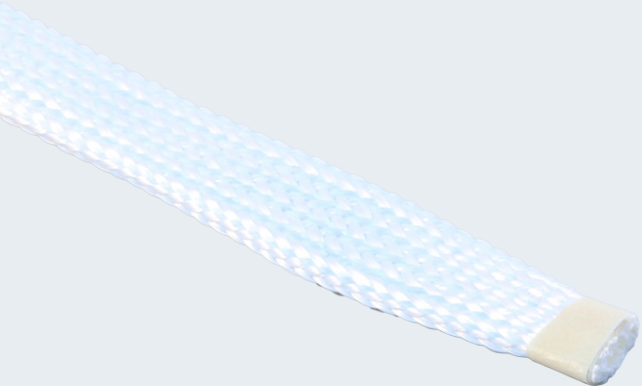

- Nextel™ 312 ceramic tubular braid
- Continuous use temperature 1200°C
- Low elongation and shrinkage at operating temperature
- Low moisture absorption
- Good chemical resistance
- Good abrasion resistance
- Fire-resistant, will not melt

How To Order		
Sample Part Number	102-101	-016
Basic No.	Ceramic tubular braid (Nextel 312)	
Braid Diameter No.	See Table I	

Table I: Size	
Dash No.	Nominal I.D.
-004	.125 (3.2)
-008	.250 (6.4)
-012	.375 (9.5)
-016	.500 (12.7)
-024	.750 (19.1)
-032	1.000 (25.4)



Nextel™ 312 tubular braid is composed of 312 grade continuous fiber that offers strength and flexibility, even in constant high temperature environments. Its properties include low thermal conductivity and thermal shock resistance, making it ideal for applications that require a flame barrier or thermal shield. It outperforms other high temperature textiles like aramids and fiberglass.

NOTES

1. Material - continuous Nextel™ 312 yarn is a ceramic fiber

BRAIDED WIRE PROTECTION

Bulk tubular non-metallic braid for wire harness protection



103-013 Unbonded tubular braid, Nomex[®], flame resistant



GY Gray

GN Green

W White

R Red

OR Orange

TN Desert Tan

Standard Black

How To Order			
Sample Part Number	103-013	-008	W
Basic No.	Unbonded tubular braid, Nomex [®]		
Braid Diameter No.	See Table I		
Color option	W = White R = Red GN = Green GY = Gray TN = Desert Tan OR = Orange Omit = for standard Black		

Table I			
Dash No.	Nominal I.D.	Wire Bundle Accomodation Range Ref.	
		Min.	Max.
-002	.062 (1.6)	.039 (1.0)	.090 (2.3)
-004	.125 (3.2)	.090 (2.3)	.160 (4.1)
-006	.188 (4.8)	.109 (2.8)	.240 (6.1)
-008	.250 (6.4)	.125 (3.2)	.312 (7.9)
-012	.375 (9.5)	.250 (6.4)	.450 (11.4)
-016	.500 (12.7)	.312 (7.9)	.625 (15.9)
-020	.625 (15.9)	.394 (10.0)	.787 (20.0)
-024	.750 (19.1)	.500 (12.7)	.900 (22.9)
-032	1.000 (25.4)	.787 (20.0)	1.375 (34.9)
-040	1.250 (31.8)	.750 (19.1)	1.390 (35.3)
-048	1.500 (38.1)	1.100 (27.9)	1.750 (44.5)
-064	2.000 (50.8)	1.750 (44.5)	2.250 (57.2)



- Soft, unbonded yarn, tubular braid, Nomex[®]
- -55° to +200°C temperature range
- 90,000 PSI yield tensile strength
- 25% elongation
- Excellent chemical resistance
- Good abrasion resistance
- Will not melt



General-duty abrasion-resistant unbonded yarn, Nomex[®] is well-suited for mechanical protection of soldier Personal Area Network cabling. Available in a broad range of colors, the soft, flexible, and durable material resists fraying and piling common to less robust yarns. In addition to improved flame resistance, unbonded braid, Nomex[®] offers superior flexibility compared to bonded solutions.

NOTES

1. Material - DuPont[™] Nomex[®] per MIL-C-572G, Type: PAA Form Y. DuPont[™] and Nomex[®] are trademarks or registered trademarks of E.I. duPont de Nemours and Company.
2. Minimum order length = 100 ft. (30.5m)

BRAIDED WIRE PROTECTION

Bulk tubular non-metallic braid for wire harness protection



103-106 Unbonded tubular braid, Nomex[®], high-temp tolerant

103-106 TUBULAR BRAID, NOMEX[®] - HIGH-TEMPERATURE TOLERANT



How To Order					
Sample Part Number	103-106	-500-10	-B	-R	-L
Basic No.	Unbonded tubular braid, Nomex [®]				
Braid Diameter No.	See Table I				
Braid Color option	GN = Green GY = Gray R = Red W = White/Ivory				
Tracer Color option	B = Black GN = Green GY = Gray R = Red W = White/Ivory Omit for none				
Lanyard option	L = Lanyard Omit for none				

-Table I				
Dash No.	Nominal I.D.	Wire Bundle Accomodation Range Ref.		Weight (Ref) lbs. / 1000 ft.
		Min.	Max.	
-062-02	.062 (1.6)	.039 (1.0)	.079 (2.0)	1.68
-125-04	.125 (3.2)	.079 (2.0)	.158 (4.0)	2.69
-250-06	.250 (6.4)	.158 (4.0)	.315 (8.0)	5.38
-375-08	.375 (9.5)	.236 (6.0)	.472 (12.0)	8.07
-500-10	.500 (12.7)	.315 (8.0)	.630 (16.0)	9.41
-625-15	.625 (15.9)	.394 (10.0)	.787 (20.0)	11.43
-750-20	.750 (19.1)	.472 (12.0)	.945 (24.0)	14.79
-875-25	.875 (22.2)	.591 (15.0)	1.181 (30.0)	21.85
-1000-30	1.000 (25.4)	.787 (20.0)	1.375 (34.9)	25.55



- Soft unbonded yarn tubular braid, Nomex[®]
- -60° to +240°C high-temperature tolerance
- 90,000 PSI yield tensile strength
- 25% elongation
- Excellent chemical resistance
- Good abrasion resistance
- Will not melt



103-106 unbonded tubular braid, Nomex[®] brings the same properties of our series 103-013 tubular braid, with superior temperature tolerance from -60°C to +240°C. Currently available in four colors—with tracer options for easy wire bundle identification—the soft unbonded material is ideally suited for a broad range of harsh-environment applications that depend on abrasion resistance and environmental performance.

NOTES

1. Material - DuPont[™] Nomex[®] per MIL-C-572G, Type: PAA Form Y. Nomex[®] to be 200 Denier, 6 ends, unbonded. DuPont[™] and Nomex[®] are trademarks or registered trademarks of E.I. duPont de Nemours and Company.
2. Lanyard material: Polyester Muletape #WP400N (300 lb.)
3. -GN color may vary from lot to lot, ranging from olive drab to forest green
4. Minimum order length = 100 ft. (30.5m)

BRAIDED WIRE PROTECTION

Bulk tubular non-metallic braid for wire harness protection



103-062 bonded yarn, Nomex®

103-062 BONDED YARN, NOMEMX®



GN Green

WH White

Standard Black

How To Order			
Sample Part Number	103-062	-008	GN
Basic No.	Bonded tubular braid, Nomex®		
Dash Number	See Table I		
Color Option	GN = Green (Sage) CA = Camouflage WH = White Omit for standard Black		

Table I			
Dash No.	Nominal I.D.	Wire Bundle Accomodation Range Ref.	
		Min.	Max.
004	.125 (3.2)	.090 (2.3)	.160 (4.1)
008	.250 (6.4)	.125 (3.2)	.312 (7.9)
012	.375 (9.5)	.312 (7.9)	.450 (11.4)
016	.500 (12.7)	.250 (6.4)	.625 (15.9)
020	.625 (15.9)	.390 (9.9)	.780 (19.8)
024	.750 (19.1)	.500 (12.7)	.900 (22.9)
032	1.000 (25.4)	.787 (20.0)	1.375 (34.9)
040	1.250 (31.8)	.750 (19.0)	1.390 (35.3)



- Bonded yarn, tubular braid, Nomex®
- Outstanding resistance to fraying and piling
- Superior chemical resistance including solvents, hydraulic fluids, fuels, and lubricants
- -60° to +240°C temperature range
- 90,000 PSI yield tensile strength
- 25% elongation
- Good abrasion resistance



Bonded yarn, tubular braid, Nomex® brings all the same popular properties of our unbonded series 103-013 tubular braid, adding superior abrasion performance, chemical resistance, and reduced fraying and piling compared to softer, unbonded solutions. Currently available in standard black, white, and green colors, the material offers temperature tolerance in a range from -60°C to +240°C.

NOTES

1. Material - DuPont™ Nomex® per MIL-C-572G, Type: PAA Form Y. Nomex® to be 200 Denier, 4 ends, bonded. DuPont™ and Nomex® are trademarks or registered trademarks of E.I. duPont de Nemours and Company.
2. -GN color may vary from lot to lot, ranging from iridescent bronze to brown, including olive drab and forest green. Contact the factory for additional available color options.
3. Minimum order length = 100 ft. (30.5m)

BRAIDED WIRE PROTECTION

Bulk tubular non-metallic braid for wire harness protection



102-040, -041, -042, -043 Bonded braid with lanyard/tracer, Nomex®



102-040, -041, -042, -043 BONDED BRAID WITH OPTIONAL LANYARD AND TRACER, NOMEX®

How To Order				
Sample Part Number	102	-043	500-10	L W
Basic No.	Bonded tubular braid, Nomex®			
Color Option	-040 = Ivory -041 = Red -042 = Green (Olive Drab) -043 = Gray			
Dash Number	See Table I			
Lanyard Option	L = Lanyard Omit for none			
Tracer Color Option	G = Green R = Red W = White Y = Yellow Omit for none			

Table I				
Dash No.	Nominal I.D.	Wire Bundle Accomodation Range Ref.		Wt/Max Lbs/1000 ft.
		Min.	Max.	
062-02	.062 (1.6)	.039 (1.0)	.079 (2.0)	1.68
125-04	.125 (3.2)	.079 (2.0)	.158 (4.0)	2.69
250-06	.250 (6.4)	.158 (4.0)	.315 (8.0)	5.38
375-08	.375 (9.5)	.236 (6.0)	.472 (12.0)	8.07
500-10	.500 (12.7)	.315 (8.0)	.630 (16.0)	9.41
625-15	.625 (15.9)	.394 (10.0)	.787 (20.0)	11.43
750-20	.750 (19.1)	.472 (12.0)	.945 (24.0)	14.79
875-25	.875 (22.2)	.591 (15.0)	1.181 (30.0)	21.85
1000-30	1.000 (25.4)	.787 (20.0)	1.375 (34.9)	25.55



- Bonded yarn, tubular braid, Nomex® with integral lanyard and tracer
- Outstanding resistance to fraying and piling
- Superior chemical resistance including solvents, hydraulic fluids, fuels, and lubricants
- -60° to +240°C temperature range
- 90,000 PSI yield tensile strength
- 25% elongation
- Good abrasion resistance



Bonded yarn, tubular braid, Nomex® brings all the same popular properties of our unbonded 103-013 tubular braid, adding superior abrasion performance, chemical resistance, and reduced fraying and piling compared to softer, unbonded solutions. Currently available in four colors with tracer options for easy wire bundle identification, the material offers temperature tolerance in a range from -60°C to +240°C.

NOTES

1. Material - DuPont™ Nomex® per MIL-C-572G, Type: PAA Form Y. Nomex® to be 200 Denier, 4 ends, bonded. DuPont™ and Nomex® are trademarks or registered trademarks of E.I. duPont de Nemours and Company.
2. Lanyard material: Polyester Muletape #WP400N (300 lb.)
3. -042 color may vary from lot to lot, ranging from olive drab to forest green
4. Minimum order length = 100 ft. (30.5m)

B

Bulk tubular non-metallic braid for wire harness protection



103-080 Camouflage tubular braid, Nomex[®], flame resistant

103-080 TUBULAR BRAID, NOMEX[®] - CAMOUFLAGE



103-080 Camouflage braid (M-Multicam shown)

How To Order			
Sample Part Number	103-080	-024	B
Basic No.	Tubular braid, Nomex [®]		
Braid Diameter No.	See Table I		
Color option	A = A-TACS B = Battle Dress D = Desert Camo M = Multicam N = Navy Working Uniform P = MARPAT W = Winter Camo U = Urban Camo		

Table I			
Dash No.	Nominal I.D.	Wire Bundle Accomodation Range Ref.	
		Min.	Max.
-002	.062 (1.6)	.039 (1.0)	.090 (2.3)
-004	.125 (3.2)	.090 (2.3)	.160 (4.1)
-006	.188 (4.8)	.109 (2.8)	.240 (6.1)
-008	.250 (6.4)	.125 (3.2)	.312 (7.9)
-012	.375 (9.5)	.250 (6.4)	.450 (11.4)
-016	.500 (12.7)	.312 (7.9)	.625 (15.9)
-020	.625 (15.9)	.394 (10.0)	.787 (20.0)
-024	.750 (19.1)	.500 (12.7)	.900 (22.9)
-032	1.000 (25.4)	.787 (20.0)	1.375 (34.9)
-040	1.250 (31.8)	.750 (19.1)	1.390 (35.3)
-048	1.500 (38.1)	1.100 (27.9)	1.750 (44.5)
-064	2.000 (50.8)	1.750 (44.5)	2.250 (57.2)



Glenair offers its popular tubular braid, Nomex[®] non-metallic wire protection sleeving in a broad range of camouflage braidings including Desert Camo, Multicam, Battle Dress, and Winter Camo. Consult factory for availability.

NOTES

Material - DuPont[™] Nomex[®] per MIL-C-572G, type PAA form Y.

DuPont[™] and Nomex[®] are trademarks or registered trademarks of E.I. duPont de Nemours and Company.

BRAIDED WIRE PROTECTION

Bulk tubular non-metallic braid for wire harness protection



102-001 and -002 expandable polyethylene tubular braid

EXPANDABLE POLYETHYLENE TUBULAR BRAID, WHITE (-001) AND BLACK (-002)



-001 White

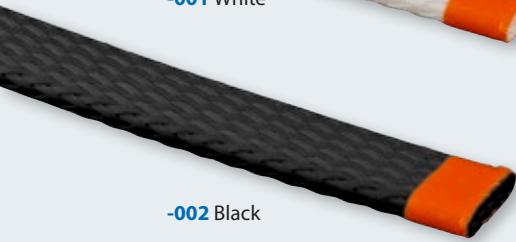

-002 Black



- **Monofilament polyethylene tubular braid**
- **-55° to +125°C temperature range**
- **50,000 PSI yield tensile strength**
- **20% elongation**
- **Good chemical resistance**
- **Good abrasion resistance**

How To Order				
Sample Part Number	102-001	-008	R	-645
Basic No.	102-001 white polyethylene braid 102-002 black polyethylene braid (see Table I)			
Braid Diameter No.	See Table II			
Tracer color option	G = green W = white R = red Y = yellow Omit for none			
Split braid option (-002 only)	-645 (add to 102-002 black braid part number only)			

Table I					
Product Series	Color	Material	Material Dia.	Wall Thickness Nominal	Temperature Range
102-001	White	Polyethylene Terephthalate	.010 (0.25)	.025 (0.6)	-65°F [-54°C] to +250°F [+121°C]
102-002	Black				

Table II					
Dash No.	Ø Nom.	Ref. wire bundle range		Approx. Weight (grams/ft.)	Wall thickness (nominal)
		Min	Max		
-004	.125 (3.2)	.090 (2.3)	.250 (6.4)	.7	.025 (0.6)
-006	.188 (4.8)	.109 (2.8)	.318 (8.1)	1.0	
-008	.250 (6.4)	.125 (3.2)	.375 (9.5)	1.4	
-012	.375 (9.5)	.312 (7.9)	.500 (12.7)	1.9	
-016	.500 (12.7)	.375 (9.5)	.750 (19.1)	3.0	
-020	.625 (15.9)	.375 (9.5)	1.000 (25.4)	3.1	
-024	.750 (19.1)	.500 (12.7)	1.250 (31.8)	3.3	
-032	1.000 (25.4)	.625 (15.9)	1.375 (34.9)	5.8	
-040	1.250 (31.8)	.750 (19.1)	1.500 (38.1)	7.0	
-048	1.500 (38.1)	.781 (19.8)	1.750 (44.5)	8.4	
-056	1.750 (44.5)	.859 (21.8)	1.938 (49.2)	10.1	
-064	2.000 (50.8)	.937 (23.8)	2.187 (55.5)	12.6	



Ideally suited for applications as diverse as rail transportation, marine, and military vehicles, our 102-001 and -002 polyethylene tubular braid is an economical choice with good general-purpose chemical and abrasion resistance. The monofilament material offers wide expandability for quick and easy installation over cable bundles and connectors.

NOTES

1. Material - polyethylene terephthalate, .010 (0.25) dia.
2. Temperature range -54°C to +125°C

B

Bulk tubular non-metallic braid for wire harness protection

102-080 Ryton tubular braid



- **Monofilament Ryton tubular braid**
- **-65° to +180°C temperature range**
- **19,000 PSI yield tensile strength**
- **40% elongation**
- **Excellent chemical resistance**
- **Excellent abrasion resistance**

102-080 RYTON TUBULAR BRAID, NATURAL COLOR

How To Order		
Sample Part Number	102-080	-008
Basic No.	Ryton tubular braid	
Braid Diameter No.	See Table I	

Table I			
Part No.	Nominal I.D.	Wire Bundle Accommodation Range Ref.	
		Min.	Max.
-004	.125 (3.2)	.125 (3.2)	.250 (6.4)
-008	.250 (6.4)	.250 (6.4)	.500 (12.7)
-016	.500 (12.7)	.375 (9.5)	.750 (19.1)
-024	.750 (19.1)	.500 (12.7)	1.250 (31.8)
-040	1.250 (31.8)	.750 (19.1)	1.750 (44.5)



102-080 Ryton is a versatile sleeving material used in mid-temperature applications. Ryton is a lightweight sleeving material with excellent chemical resistance and dimensional stability.

NOTES

1. Material - Ryton R-7, natural color (tan)
2. Minimum order length is 100 ft. (30.5m)

Bulk tubular non-metallic braid for wire harness protection

100-022 high-temperature range PTFE glass tubular braid



- Highly flexible PTFE-glass tubular braided sleeving with outstanding high- and low-temperature resistance (-200°C to +525°C)
- Ideally suited for rugged wire harness protection in proximity to engines and galleys
- Highly resistant to contaminants and toxic chemicals per ASTM D-570
- Smooth surface resistant to snagging and breakage

100-022 HIGH-TEMPERATURE PTFE-COATED FIBERGLASS BRAID, NATURAL COLOR

How To Order		
Sample Part Number	100-022	-012
Basic No.	PTFE-glass tubular braid	
Braid Diameter No.	See Table I	

Table I: Size	
Dash No.	Nominal I.D.
-004	.125 (3.2)
-005	.156 (4.0)
-006	.188 (4.7)
-008	.250 (6.4)
-012	.375 (9.5)
-016	.500 (12.7)
-020	.625 (15.9)
-024	.750 (19.1)
-032	1.000 (25.4)
-040	1.250 (31.8)
-048	1.500 (38.1)



Glass-filled PTFE fire resistant braided shielding is ideally suited for cable protection adjacent high-heat engine applications

NOTES

1. Material - braided fiberglass, PTFE coated, natural color IAW MIL-C-20079H
2. Temperature range -200°C to +525°C
3. Minimum order length - 100 ft. (30.5m)

B

WITH ARMORLITE™ TECHNOLOGY



MasterWrap™ flexible, lightweight wraparound EMI/RFI shielding and abrasion protection for spot EMI/RFI shielding coverage and repair of wire harnesses

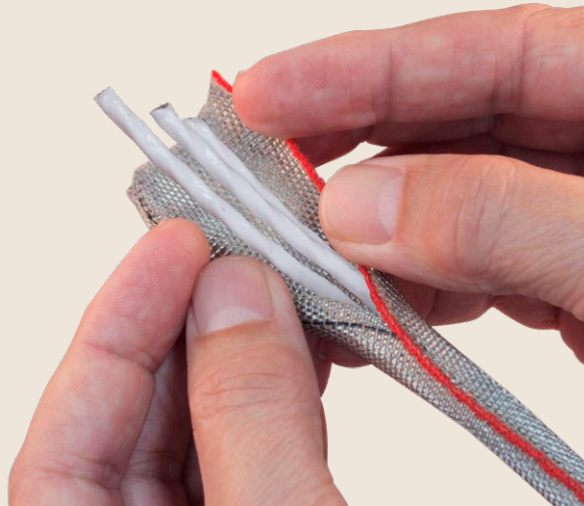

- Up to 70% weight reduction compared to standard metallic EMI shielding
- Replaces harder-to-install tubular EMI/RFI sleeving
- Fast and easy side-entry installation and removal
- Reduces windowing and coverage gaps
- Superior flexibility, durability and reparability
- Temperature tolerant from -65°C to 260°C
- High-frequency EMI shielding performance comparable to standard metallic and lightweight tubular braid
- Outstanding abrasion and mechanical protection
- Halogen-free and RoHS compliant
- 500 hour salt spray corrosion resistance
- 50,000 cycle 90°–120° bend flex tested
- Outstanding caustic chemical and corrosive fluid resistance

Tubular braided sleeving meets the broad range of EMC shielding and mechanical protection requirements of aircraft harness assemblies. But the need to apply conductive shielding materials over installed aircraft wire and cable bundles requires new technology. Legacy self-wrapping cable braid has long been available for EMI/RFI applications and abrasion protection, albeit with poor performance due to its heavy weight, inflexibility, and “windowing,” which results in poor shielding performance. MasterWrap™, a lightweight, easy-to-install, side-entry, self-wrapping shielding solution—incorporating Glenair microfilament ArmorLite™ and composite thermoplastic PEEK fibers—solves these problems and more. MasterWrap™ is ideally suited for both long-run wire harness protection as well as spot coverage and maintenance of EMC cable applications—all with outstanding weight reduction and ease-of-assembly. MasterWrap™ is qualified for use at major aircraft manufacturers for both long cable runs and spot coverage and repairs.

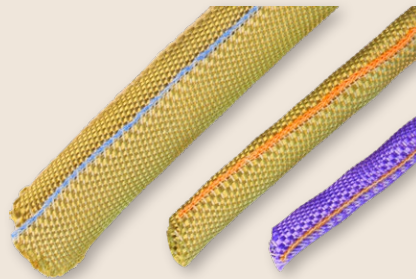

MATERIAL CONSTRUCTION AND HANDLING PERFORMANCE

Flexible material eliminates kinking and windowing · Spring members ensure shielding stays tight to wire bundle

Ultra-lightweight microfilament stainless steel core, plated with conductive nickel for outstanding shielding performance



Interwoven with high-temperature PEEK composite thermoplastic spring members that ensure up to 95% optical coverage

- Material design provides uniform surface with limited interference to structures and clamps
- Provides optimum surface coverage and adherence to wire bundle without buckling during both straight and angled routing
- MasterWrap delivers increased abrasion protection with additional axial edge strength members compared to standard tubular braided shielding
- Reduces kinking and windowing compared to full metal braid solutions for excellent shielding performance

WITH ARMORLITE™ TECHNOLOGY

MasterWrap™ flexible, lightweight wraparound EMI/RFI shielding and abrasion protection



for spot EMI/RFI shielding coverage and repair of wire harnesses

HERE'S WHAT YOU NEED TO KNOW ABOUT WEIGHT

Weight of standard metallic tubular braided cable shielding		
EMI Braided Shielding Type (measured samples all 1/2" diameter)	Weight g/ft	Weight g/m
Glenair nickel-clad copper braid	21.6	70.9
Raychem RAY-103-12.5 nickel-clad copper braid	21.9	72.0
Weight of lightweight tubular (LWB) braided cable shielding		
AmberStrand® 100%	3.7	12.1
AmberStrand® 75% / NiCu 25%	4.9	16.1
ArmorLite™ 100%	4.4	14.4
ArmorLite™ 75% / NiCu 25%	5.4	17.7
Raychem INSTALITE	13.4	44.0
Weight of side-entry self-wrapping braided cable shielding		
MasterWrap™	6.2	20.3
Federal Mogul ROUNDIT® EMI FMJ	18.0	59
Federal Mogul ROUNDIT® EMI C27 XWS	23.5	77



100-003
tubular metal
braid ASTM B355 Class 7
OFHC nickel-plated copper



103-051
ArmorLite™
microfilament nickel-clad
stainless steel

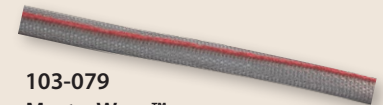

103-079
MasterWrap™
side-entry shield braid

Mechanical and Environmental Performance Summary		
Vibration	No evidence of wear or visible defect	DO-160G Cat S and H
Abrasion	No evidence of wear, visible defect or electrical degradation	EN-3475-511:2002
High Temperature Exposure	168 hours at 200°C; no visual or electrical degradation	EN 6059-302 part 302
Rapid Change of Temperature	10 hour hot and cold cycling; no evidence of wear or visible defect	EN 6059-308 part 308
Vertical Flammability	Pass	14 CFR part 25.853
Fluid Immersion Testing	No visual or electrical degradation	DO-160G
Bending Properties	25000 cycles; no breakage, no plating delamination	EN 6059-402
Salt Fog 500 Hours	No evidence of base metal on braid	ASTM B117-03 Sodium Chloride 5%

MasterWrap is compatible with most aerospace industry fluids. Consult factory for specifics.

WHAT YOU NEED TO KNOW ABOUT EMI/RFI SHIELDING PERFORMANCE

	NiCu	Armorlite™	Amberstrand®	MasterWrap™
TRANSFER IMPEDANCE (Per IEC 62153-4) (Max values for 1/2 inch diameter shields)				
FREQUENCY				
10 KHz	5 mΩ/m	50 mΩ/m	60 mΩ/m	40 mΩ/m
100 KHz	5 mΩ/m	50 mΩ/m	60 mΩ/m	40 mΩ/m
1 MHz	12 mΩ/m	50 mΩ/m	60 mΩ/m	40 mΩ/m
10 MHz	80 mΩ/m	50 mΩ/m	80 mΩ/m	40 mΩ/m
100 MHz	130 mΩ/m	30 mΩ/m	110 mΩ/m	80 mΩ/m
SHIELDING ATTENUATION (Per IEC 62153-4) (Min values for 1/2 inch diameter shields)				
FREQUENCY				
1 GHz	38 dB	55 dB	48 dB	40 dB
3 GHz	40 dB	60 dB	55 dB	35 dB
5 GHz	44 dB	60 dB	60 dB	45 dB
8 GHz	40 dB	50 dB	60 dB	40 dB
WEIGHT	70.9 g/m	14.4 g/m	12.1 g/m	20.3 g/m

The table at left is a useful summary of MasterWrap™ shielding performance compared to NiCu and lightweight braid. Transfer impedance and shielding attenuation data is supplied for 1/2" diameter test samples. At high frequencies, both LWB and MasterWrap™ provide comparable and even superior performance to nickel-copper due to reduced windowing and superior optical coverage with significant reduction in weight. Further improvements in high-frequency shielding attenuation can be achieved using conductive tape wraps and/or via hybrid blends of LWB and NiCu.

MasterWrap™ ArmorLite: flexible, lightweight wraparound EMI/RFI shielding

for long runs and spot coverage



MASTERWRAP ARMORLITE: DIMENSIONAL INFORMATION • HOW TO ORDER

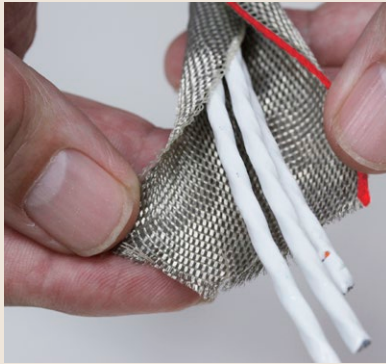

How To Order		
Sample Part Number	103-079	-024
Basic No.	MasterWrap™ ArmorLite material	
Dash No.	See Table I	

Table I									
Dash No	Nominal I.D. (Ref.)		Ref. Wire Bundle Range Nominal		Approx. Weight Grams/Ft.	Approx. Milliohms / Meter	Min. Pull Strength (lbs)	Size Indicator color code	Quantity feet/spool
	In.	mm	In.	mm					
004	.125	3.2	.093 .170	2.4 4.3	2.1	99.8	39	Black	50-500
008	.250	6.4	.170 .300	4.3 7.6	4.0	52.2	75	Brown	50-400
012	.375	9.5	.300 .406	7.6 10.3	5.0	41.8	94	Red	50-300
016	.500	12.7	.406 .520	10.3 13.2	6.2	34.0	116	Orange	50-250
020	.625	15.9	.520 .675	13.2 17.2	8.7	24.2	158	Yellow	50-200
024	.750	19.1	.675 .825	17.2 21.0	10.6	20.0	193	Green	50-100
032	1.000	25.4	.825 1.100	21.0 27.9	12.9	16.4	237	Blue	50-100
040	1.250	31.8	.938 1.312	23.8 38.3	17.4	TBD	TBD	Violet	50-100
048	1.500	38.1	1.187 1.575	30.1 40.4	21.2	TBD	TBD	Gray	50-100
064	2.000	50.8	1.575 2.090	33.0 53.1	25.8	TBD	TBD	White	50-100

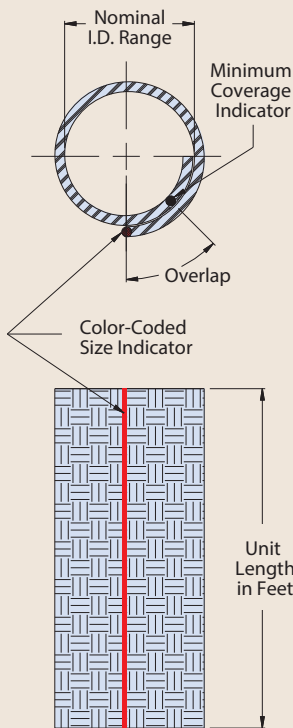

NOTES

Product ordered in 1 foot increments, packaged in boxed spools. See Table I. Lengths of 1-49 feet will be packaged in individual polybags.

Materials:

Woven mesh - ArmorLite microfilament nickel-clad 316L stainless steel; Monofilament - PEEK; Overlap tracer - high temperature DuPont™ Nomex® thread
 DuPont™ and Nomex® are trademarks or registered trademarks of E.I. duPont de Nemours and Company.

AVAILABLE WIRE LOOM TOOL FOR EASY ASSEMBLY FOR ALL MASTERWRAP™ PRODUCTS

Select size based on max bundle diameter



Part Number	Max Bundle Dia.
600-180-08	3/8 in (8mm)
600-180-15	5/8 in (15mm)
600-180-20	3/4 in (20mm)
600-180-25	1 in (25 mm)
600-180-32	1 1/4 in (32mm)

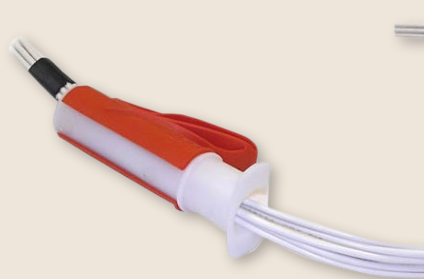

Easy to use: simply gather wire bundle into the tool...

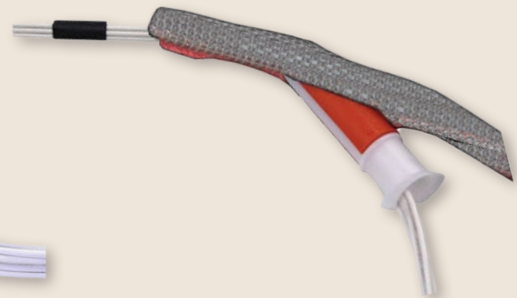

...Insert tool and wires into MasterWrap and run through

NEW MASTERWRAP™ WITH NOMEMEX®

MasterWrap™ 103-095 (Nomex®) flexible, lightweight wraparound abrasion / thermal protection

for spot mechanical coverage and repair of wire harnesses



MasterWrap™

MASTERWRAP (NOMEMEX®): DIMENSIONAL INFORMATION • HOW TO ORDER

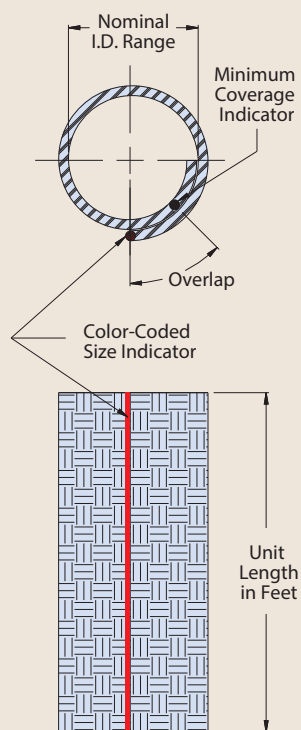

How To Order			
Sample Part Number	103-095	-024	GY
Basic No.	MasterWrap™ (Nomex®) material		
Dash No.	See Table I		
Color option	W = White R = Red GN = Green GY = Gray TN = Desert Tan OR = Orange Omit = for standard Black		

Table I								
Dash No	Nominal I.D. (Ref.)		Ref. Wire Bundle Range Nominal		Approx. Weight Grams/Ft.	Min. Pull Strength (lbs)	Size Indicator color code	Quantity feet/spool
	In.	mm	In.	mm				
004	.125	3.2	.093 .170	2.4 4.3	1.8	39	Black	50-500
008	.250	6.4	.170 .300	4.3 7.6	2.3	75	Brown	50-400
012	.375	9.5	.300 .406	7.6 10.3	3.2	94	Red	50-300
016	.500	12.7	.406 .520	10.3 13.2	3.7	116	Orange	50-250
020	.625	15.9	.520 .675	13.2 17.2	5.0	158	Yellow	50-200
024	.750	19.1	.675 .825	17.2 21.0	6.0	193	Green	50-100
032	1.000	25.4	.825 1.100	21.0 27.9	7.3	237	Blue	50-100
040	1.250	31.8	.938 1.312	23.8 38.3	10.0	TBD	Violet	50-75
048	1.500	38.1	1.187 1.590	30.1 40.4	11.0	TBD	Gray	50
064	2.000	50.8	1.812 2.090	33.0 53.1	12.2	TBD	White	50

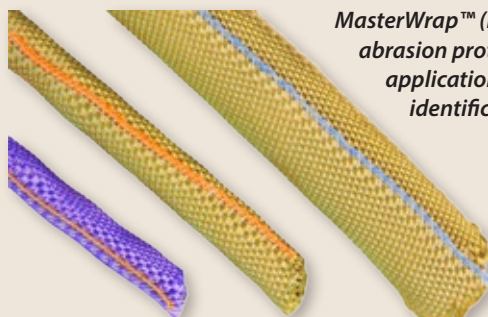

MasterWrap™ (Nomex®) is the ideal solution for mechanical abrasion protection of wire bundle harnessing in aircraft applications. Available color selections allow for easy identification and labeling of wire circuitry.

NOTES

Product ordered in 1 foot increments, packaged in boxed spools. See Table I. Lengths of 1-49 feet will be packaged in individual polybags.

Materials:

Woven mesh - high temperature DuPont™ Nomex®; Monofilament - PEEK; Overlap tracer - high temperature DuPont™ Nomex® thread

DuPont™ and Nomex® are trademarks or registered trademarks of E.I. duPont de Nemours and Company.

ArmorLite™ mesh tape: flexible, lightweight woven solution for spot EMI coverage and repairs

103-058 ArmorLite™ mesh tape (non-adhesive)

103-058 ARMORLITE LIGHTWEIGHT SHIELDING TAPE FOR 360° EMI SPOT COVERAGE AND REPAIR



How To Order		
Sample Part Number	103-058	-1
Basic No.	ArmorLite™ tape	
Dash No.	1 = .50" wide tape 2 = 1.00" wide tape 3 = 1.50" wide tape (see Table I for specifications)	

Table I				
Dash No.	Nominal Width 'A' Dim.	Approx. Weight (grams/ft.)	Milliohms per meter ref.	Minimum pull strength (lbs) ref.
-1	.50" (12.7mm)	2.1	99.8	39
-2	1.00" (25.4mm)	4.0	52.2	75
-3	1.50" (38.1mm)	6.1	TBD	120

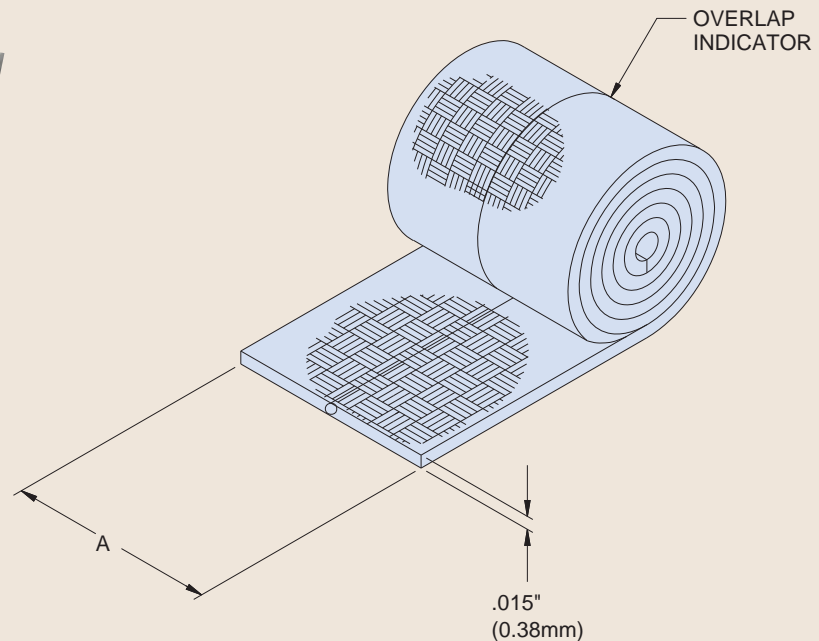

NOTES

- Order in 1 foot increments. Standard packaging on spools in 50 ft. lengths. Orders of 1–49 ft. will be packaged in individual polybags.

Material:

- Woven mesh - ArmorLite™ microfilament (nickel clad 316L stainless steel); Overlap tracer - high temperature DuPont™ Nomex® thread; Monofilament - PEEK

DuPont™ and Nomex® are trademarks or registered trademarks of E.I. duPont de Nemours and Company.

Mesh tape, Nomex®: flexible, lightweight woven solution for spot mechanical/abrasion protection

103-102 Mesh tape, Nomex® (non-adhesive)



How To Order			
Sample Part Number	103-102	-1	GY
Basic No.	Mesh tape, Nomex®		
Dash No.	1 = .50" wide tape 2 = 1.00" wide tape 3 = 1.50" wide tape (see Table I for specifications)		
Color option	W = White R = Red GN = Green GY = Gray TN = Desert Tan OR = Orange Omit = for standard Black		

Dash No.	Nominal Width 'A' Dim.	Approx. Weight (grams/ft.)	Minimum pull strength (lbs) ref.
-1	.50" (12.7mm)	1.5	TBD
-2	1.00" (25.4mm)	3.0	TBD
-3	1.50" (38.1mm)	4.5	TBD

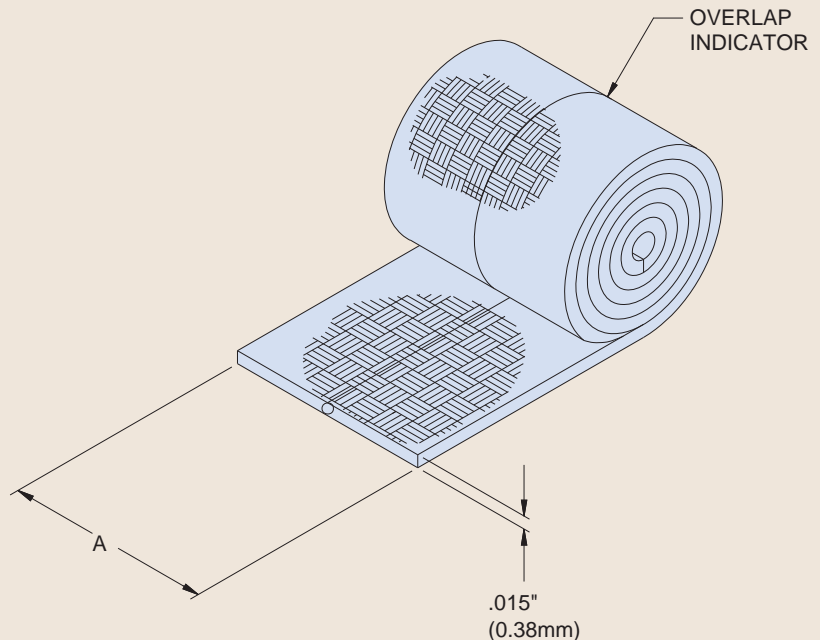

NOTES

- 1. Order in 1 foot increments. Standard packaging on spools in 50 ft. lengths. Orders of 1–49 ft. will be packaged in individual polybags.

Material:

Woven mesh and overlap tracer - high temperature DuPont™ Nomex® thread;
Monofilament - PEEK

DuPont™ and Nomex® are trademarks or registered trademarks of E.I. duPont de Nemours and Company.

Tapered tubular metal braid

ArmorLite™, AmberStrand®, nickel-, silver-, or tin-copper

100-041

TAPERED TUBULAR METAL BRAID, AMBERSTRAND®, ARMORLITE™, NICKEL/COPPER, SILVER/COPPER OR TIN/COPPER



Dash nos. 02-12 flared or folded back in this area

How To Order	
Sample Part Number	100-041 -06 T 10 A
Basic No.	Tapered tubular metal braid
Braid Diameter No.	See Table I
Braid Material	L = 100% ArmorLite N = Nickel/Copper S = Silver/Copper T = Tin/Copper A = 100% AmberStrand® B = 75% / 25% AmberStrand®
Length	in 1 inch increments
Wire Gage Option (N, S, and T materials only)	A = 36 AWG Omit = Standard 34 AWG

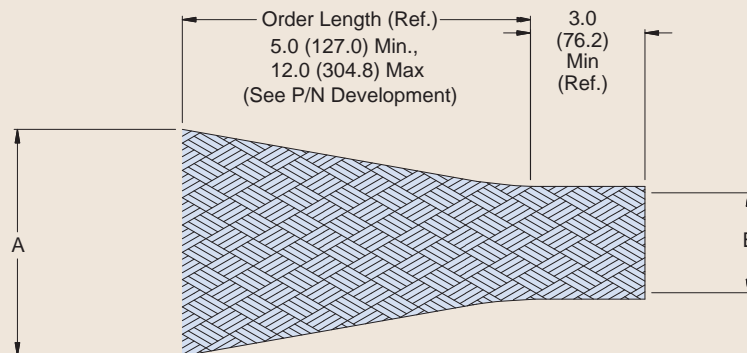

Table I: Part Numbers and Sizes				
Braid Diameter Number	A (large end dia.)		B (small end dia.)	
	+ .10 - .00	(2.5) (0.0)	+ .10 - .00	(2.5) (0.0)
-01	.30	(7.6)	.15	(3.8)
-02	.45	(11.4)	.30	(7.6)
-03	.60	(15.2)	.30	(7.6)
-04	.75	(19.1)	.30	(7.6)
-05	.75	(19.1)	.50	(12.7)
-06	1.05	(26.7)	.50	(12.7)
-07	1.05	(26.7)	.75	(19.1)
-08	1.20	(30.5)	.75	(19.1)
-09	1.20	(30.5)	1.00	(25.4)
-10	1.50	(38.1)	.75	(19.1)
-11	1.50	(38.1)	1.00	(25.4)
-12	1.50	(38.1)	1.20	(30.5)
-13	.88	(22.4)	.50	(12.7)
-14	1.38	(35.1)	.75	(19.1)

MATERIAL/FINISH

Copper with Nickel, Silver, or Tin finish. 18° to 30°, 34 or 36 AWG, 85% minimum coverage

ArmorLite - Stainless Steel / Nickel plated

AmberStrand (A) - Composite / Nickel plated

AmberStrand (B) - Composite 75%, Nickel Copper 25%

Nickel 200 Tubular metal braid

Special-Purpose for Shipboard Applications

100-218

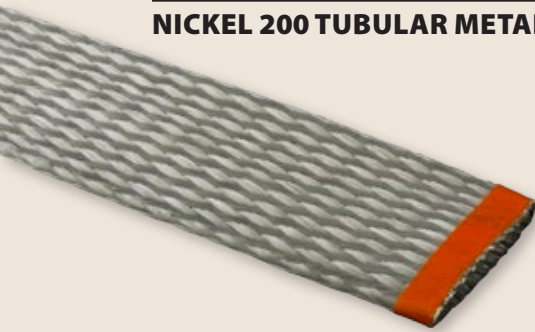

NICKEL 200 TUBULAR METAL BRAID

How To Order				
Sample Part Number	100-218	A	203	L
Basic No.	Nickel 200 tubular braid			
Wire Gage	A = 36 AWG B = 34 AWG C = 32 AWG D = 30 AWG			
Dash Number	See Tables I, II, III, IV, and V			
Lanyard Option	L = with Lanyard Omit for none			

Table I: 36 AWG

Dash No.	Nominal I.D.	Carriers per Layer	Ends per Layer
031	.031 (0.8)	24	24
062	.062 (1.6)	24	48
078	.078 (2.0)	24	72
109	.109 (2.8)	24	96
125	.125 (3.2)	24	120
156	.156 (4.0)	24	240
171	.171 (4.3)	24	168
188	.188 (4.8)	24	192
203	.203 (5.2)	24	312
250	.250 (6.4)	24	384
281	.281 (7.1)	24	216
312	.312 (7.9)	48	288
375	.375 (9.5)	48	384
437	.437 (11.1)	48	432
500	.500 (12.7)	48	528
562	.562 (14.3)	48	624
625	.625 (15.9)	48	720
750	.750 (19.1)	48	816
781	.781 (19.8)	48	864
875	.875 (22.2)	64	640
937	.937 (23.8)	64	640
1000	1.000 (25.4)	64	768
1125	1.125 (28.6)	72	792
1250	1.250 (31.8)	72	792
1375	1.375 (34.9)	72	864
1500	1.500 (38.1)	72	936
1562	1.562 (39.7)	72	984
1750	1.750 (44.5)	96	1152
2000	2.000 (50.8)	96	1152
2300	2.300 (58.4)	96	1248
2500	2.500 (63.5)	96	1248
2750	2.750 (69.9)	96	1248
3375	3.375 (85.7)	96	1440

Table II: 34 AWG

Dash No.	Nominal I.D.	Carriers per Layer	Ends per Layer
062	.062 (1.6)	16	32
109	.109 (2.8)	16	64
125	.125 (3.2)	24	72
171	.171 (4.3)	24	120
188	.188 (4.8)	24	120
203	.203 (5.2)	24	192
250	.250 (6.4)	24	192
375	.375 (9.5)	48	240
437	.437 (11.1)	48	288
500	.500 (12.7)	48	336
781	.781 (19.8)	48	528
1000	1.000 (25.4)	64	576
1125	1.125 (28.6)	72	648
1250	1.250 (31.8)	72	648
1500	1.500 (38.1)	72	720

Table III: 32 AWG

Dash No.	Nominal I.D.	Carriers per Layer	Ends per Layer
062	.062 (1.6)	16	16
109	.109 (2.8)	16	32
125	.125 (3.2)	24	48
171	.171 (4.3)	24	72
203	.203 (5.2)	24	120
250	.250 (6.4)	24	144
312	.312 (7.9)	24	144
375	.375 (9.5)	48	144
437	.437 (11.1)	24	240
500	.500 (12.7)	48	192
781	.781 (19.8)	48	336
1000	1.000 (25.4)	48	384

Table V: 38 AWG

Dash No.	Nominal I.D.	Carriers per Layer	Ends per Layer
125	.125 (3.2)	24	168
171	.171 (4.3)	24	240
203	.203 (5.2)	24	312
250	.250 (6.4)	24	288
375	.375 (9.5)	48	480
500	.500 (12.7)	48	624
625	.625 (15.9)	48	720
937	.937 (23.8)	64	640

Table IV: 30 AWG

Dash No.	Nominal I.D.	Carriers per Layer	Ends per Layer
281	.281 (7.1)	24	120
375	.375 (9.5)	24	168
437	.437 (11.1)	24	240
500	.500 (12.7)	24	360
562	.562 (14.3)	48	480
656	.656 (16.7)	48	768
781	.781 (19.8)	48	336
875	.875 (22.2)	48	336
1000	1.000 (25.4)	48	384
1125	1.125 (28.6)	48	432
1250	1.250 (31.8)	48	480
1375	1.375 (34.9)	48	528
1500	1.500 (38.1)	48	576
2000	2.000 (50.8)	48	672

NOTES

Braid Material - Nickel 200 per ASTM B160

Minimum order length = 100 feet. For longer lengths, braid will be supplied in random lengths, number of reels and size mfg. option. Continuous lengths must be specified by customer.

103-173 adhesive shielding tape

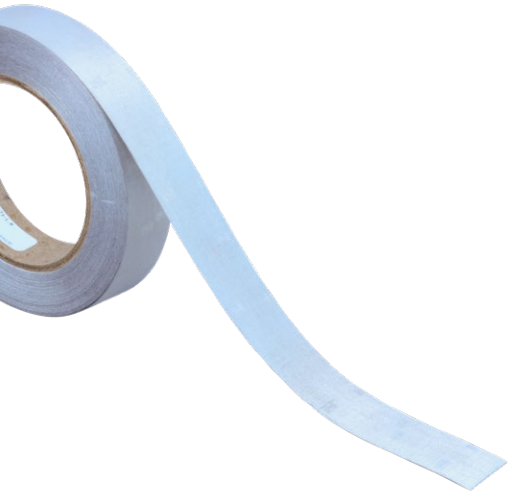

- **Lightweight, conductive fabric with a conductive adhesive for optimal EMI shielding**
- **Conforms to NASA outgassing requirements without any special processing:**
Tested per ASTM E 595
TML: 0.27%
CVCM: <0.01%
- **80 dB shielding at high frequencies per IEC 62153-4-4**
- **Service temperature range -65°C to +125°C**
- **Meets the flammability requirements of FAR 25.853, 12 second vertical burn**
- **Use to shield critical EMC terminations under overmolds**
- **Use to shield an entire cable or to patch EMI holes**
- **Conductive adhesive secures the tape in place and sticks to itself, metallic braid, backshells, and connectors**
- **Ideal for holding Glenair MasterWrap in place**

Glenair 103-173 adhesive EMI shielding tape is an ideal solution for shielding of critical EMC terminations under cable overmolds, as a patch for on-site coverage of EMI holes, or as an EMC shielding solution for entire cables. The lightweight nickel-coated copper fabric is backed with a conductive, pressure-sensitive adhesive that secures the tape in place, and adheres to itself and to EWIS components. It is an ideal finishing solution for holding Glenair MasterWrap in place. Conveniently supplied in .5", 1", and 1.5" width on 25 yard rolls.

How To Order		
Sample Part Number	103-173	0.5
Basic No.	Adhesive EMI Shielding Tape	
Tape Width	0.5 = .50" wide tape 1.0 = 1.00" wide tape 1.5 = 1.50" wide tape Supplied in 25 yd. rolls, individually polybagged.	

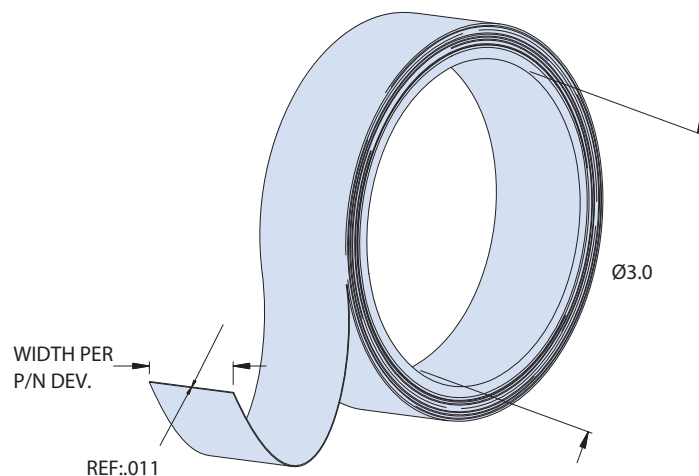
**MECHANICAL CHARACTERISTICS**

- Nickel-copper plated fabric
- Conductive pressure-sensitive adhesive/
- Paper backing
- Weight: 1.2 g/ft (X width in inches)



SERIES 107

Braided Ground Straps

for electrostatic discharge, lightning strike and power equipment grounding



A single lightning strike can hit an aircraft with as much as 1,000,000 volts. Static electricity can charge an aircraft, particularly in cold and wet air, with enough electrical potential to result in a discharge that can ignite ground fueling equipment or fry avionics gear. Power generation systems (engines, alternators, starters, etc.) can also produce transient electrical current that can damage adjacent electronic systems.

Damage from these events is minimized and managed in aircraft, Navy ships, mass transit systems and elsewhere through the use of electrical bonding. Flexible bonding straps are attached between equipment and airframes as well as between structural elements and flight control surfaces to conduct destructive electrical surges to ground or to bus bar components capable of absorbing significant amounts of transient voltage

Glenair has designed and supplies a broad range of braided ground strap technologies to both commercial and military aerospace customers, as well as US Navy and a broad range of mass transit applications. Our ground strap technologies are exactly designed with appropriate conductive and dissipative materials for each application.

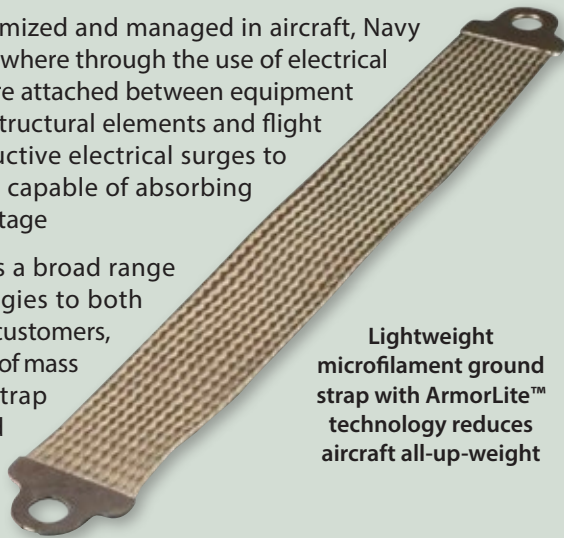

Lightweight microfilament ground strap with ArmorLite™ technology reduces aircraft all-up-weight

- Ultra-lightweight ground straps with highly conductive or dissipative performance
- Metal-clad microfilament braided solutions
- Significant contribution to weight reduction initiatives in commercial and military aircraft
- Heavy-duty variants for electrical potential grounding from engines, starters, and power units
- Mil-qualified designs for Navy shipboard applications
- Fast turnaround on requests for unusual and build-to-print requirements

Lightweight, general, and heavy-duty

LIGHTWEIGHT ARMORLITE™ MICROFILAMENT GROUND STRAPS



- Ultra lightweight metal-clad stainless steel braid material
- Low-profile lug design and assembly
- Available in seven widths and any length
- Low electrical resistance and high temperature tolerance
- High conductivity-to-weight / material-cross-section ratio
- Corrosion resistant materials for life-of-system durability
- Bend cycle durability up to 250,000 cycles per EN4199-001

GENERAL DUTY, CONFIGURABLE GROUND STRAPS



- Designed for general-purpose military and commercial aerospace as well as mass transit and industrial applications
- Nickel-plated copper lugs with configurable mounting hole options
- Broad range of standard-duty braid materials, including tin and silver-plated copper, stainless steel, and nickel 200
- Insulated sleeving option for environmental protection

MIL-DTL-24749 TYPE IV QUALIFIED GROUND STRAPS FOR NAVY SHIPBOARD APPLICATIONS



- Meets the rigorous specifications of MIL-DTL-24749 Rev. C Type IV
- Tested to survive 1000 hours salt spray
- Unique Stainless Steel/Nickel hybrid braid
- Available in six standard configurations, with non-standard length/ lug size configurations available
- Rugged square form-factor lug

FAST TURNAROUND ON UNUSUAL/BUILD-TO-PRINT REQUESTS



Hybrid braid materials and customizable lug material options



Specialized lug configurations including integrated bonding hardware and angled lugs



Heavy-duty braid and lug configurations



Round cross-section braid



Harsh environment and chemical-resistant ground strap jacketing

GROUND CONTROL EARTH BOND SYSTEM



How To Order		
600-120	Hydraulic Setting Tool for 1/4" Earth Bonds	The tools feature one hand operation and ram retract mechanism actuated by release trigger. Consult factory for control gauges and earth bond part numbers for each material type and size.
600-123	Hydraulic Setting Tool for 3/8" Earth Bonds	
600-124	Hydraulic Setting Tool for M6 Earth Bonds	
600-125	Hydraulic Setting Tool for M10 Earth Bonds	

WEIGHT-SAVING, LOW-PROFILE ArmorLite™ ESD Grounding Straps



Series 107 • Single and dual layer • soldered lugs

LIGHTWEIGHT ARMORLITE™ MICROFILAMENT GROUND STRAPS, SOLDERED LUGS

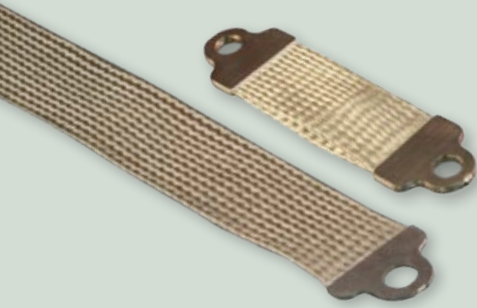

How To Order				
Sample Part Number	107-098	-A	-12	-6
Grounding Strap	-098 = Single layer light duty ArmorLite -099 = Dual layer medium duty ArmorLite			
Material	A = ArmorLite microfilament stainless steel braid			
Width Code	(See Table II)			
Length	Dimension (L) in one inch increment			

ARMORLITE™



- For grounding airframe sections, dissipating static build-up in composite structures, dissipating lightning strike energy, and grounding individual moving parts
- 70+% weight savings over standard NiCu braid
- Approved for use by major airframe and equipment manufacturers
- Lightweight, durable soldered lugs

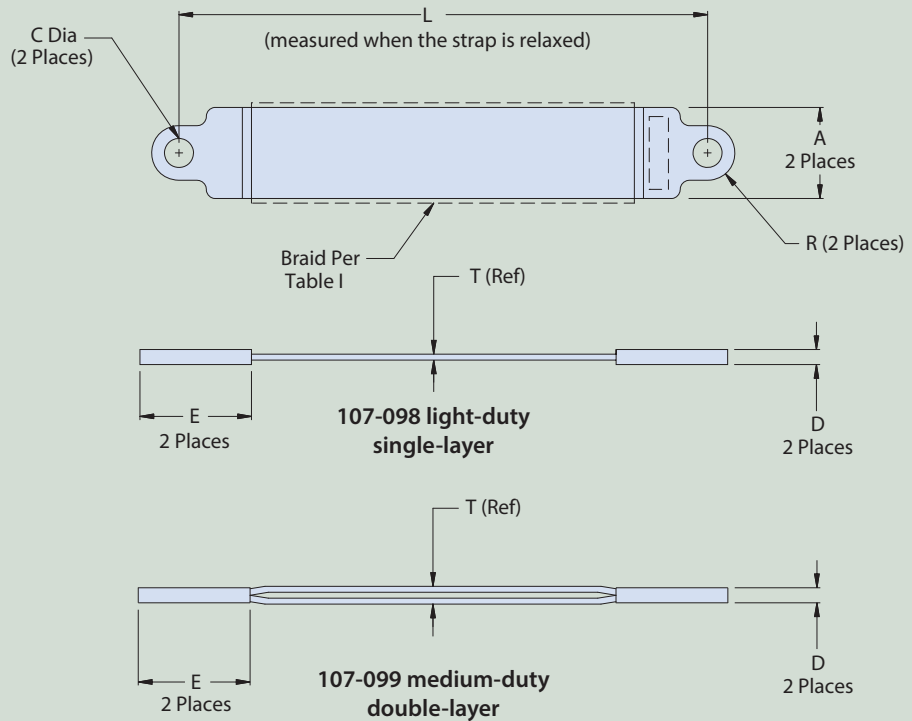

Table II: Mechanical/Electrical Parameters for ArmorLite Material

Width Code	A ± .03	C	R	D	E	T	Nom. Resistance mOhm/m* (AWG Equiv.)	Lug Junction Resistance mOhm	Weight gr/m*	Inductance nH/m (Ref. Only)	Test Current Amps**	Tensile Strength Lbf
12	.290 (7.37)	.150 (3.81)	.145 (3.68)	.042 (1.06)	.480 (12.19)	.016 (.41)	48 (22)	0.129	9.0	1277	37	130
20	.480 (12.19)	.200 (5.08)	.240 (6.10)	.042 (1.06)	.690 (17.53)	.016 (.41)	26 (19)	0.111	13.4	1170	52	216
24	.590 (14.99)	.260 (6.60)	.295 (7.49)	.042 (1.06)	.790 (20.06)	.016 (.41)	23 (18)	0.097	17.9	1116	62	219
32	.820 (2.83)	.390 (9.91)	.375 (9.53)	.052 (1.32)	.950 (24.13)	.021 (.53)	13 (16)	0.089	35.8	1047	127	483
40	.870 (22.10)	.390 (9.91)	.375 (9.53)	.052 (1.32)	.950 (24.13)	.021 (.53)	11 (15)	0.061	40.3	1034	141	524
48	1.080 (27.43)	.390 (9.91)	.375 (9.53)	.052 (1.32)	.950 (24.13)	.021 (.53)	8 (14)	0.054	53.8	983	162	590
64	1.330 (33.78)	.390 (9.91)	.375 (9.53)	.052 (1.32)	.950 (24.13)	.021 (.53)	6 (12)	0.047	71.7	936	208	723
for 107-099 double-layer straps												
48	1.080 (27.43)	.390 (9.91)	.375 (9.53)	.080 (2.03)	1.15 (29.21)	.042 (1.06)	4 (11)	0.054	107.6	976	500	590
64	1.330 (33.78)	.390 (9.91)	.375 (9.53)	.080 (2.03)	1.15 (29.21)	.042 (1.06)	3 (10)	0.047	143.4	930	650	723

* Braid only, figures exclude termination lugs. **Test current is defined as the current required to reach 200° C at ambient temperature

WEIGHT-SAVING, LOW-PROFILE ArmorLite™ ESD Grounding Straps



107-080 • Single and dual layer • configurable heavy-duty solder-free crimp lugs



LIGHTWEIGHT ARMORLITE™ MICROFILAMENT GROUND STRAPS, SOLDER-FREE CRIMP LUGS

How To Order				
Sample Part Number	107-080	S	12	A -6
Grounding Strap	-080 = ArmorLite ground strap with crimp lugs			
Layer Code	S = Single-layer braid D = Double-layer braid			
Width Code	See Table I			
Lug Hole Code	See Table II			
Length	Dimension (L) in one inch increment			



- For grounding airframe sections, dissipating static build-up in composite structures, and lightning strike energy
- 70+% weight savings over standard NiCu braid
- Approved for use by major airframe and equipment manufacturers

Table III: Lug Hole Size Codes

Lug 1 & 2 Hole Size Code	C Dia.	Stud Size (Ref.)
A	.120 / .128 (3.0 / 3.3)	#3, #4
B	.147 / .152 (3.7 / 3.9)	#5, #6
C	.172 / .180 (4.4 / 4.6)	#8
D	.199 / .204 (5.1 / 5.2)	#10
E	.257 / .266 (6.5 / 6.8)	#12, #14, 1/4
F	.323 / .328 (8.2 / 8.3)	5/16
G	.386 / .391 (9.8 / 9.9)	3/8

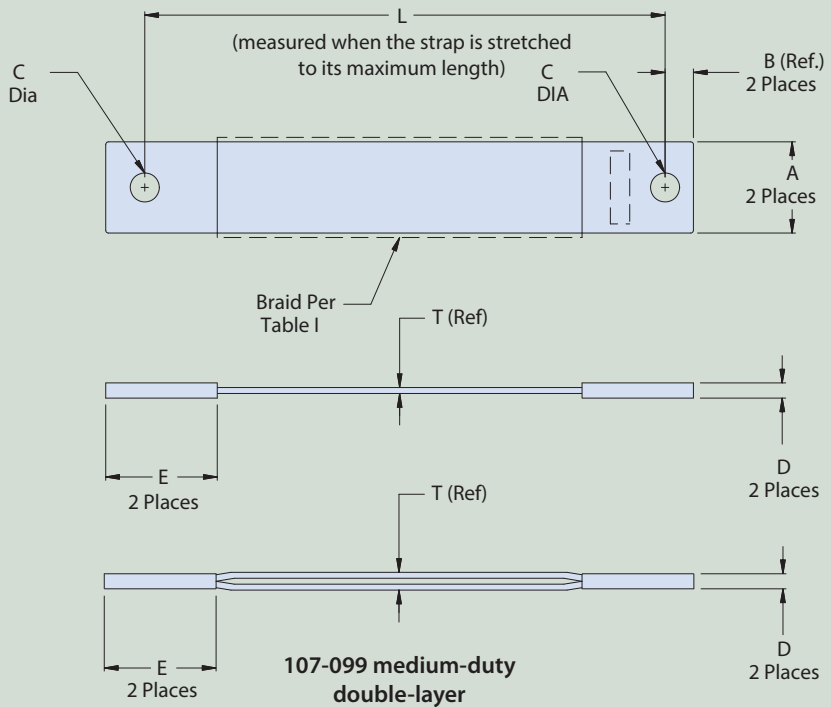

Table I: Mechanical/Electrical Parameters for ArmorLite Material

Width Code	A ± .03	B	D		E	T		Nom. Resistance mOhm/m*(AWG Equiv.)		Weight gr/m*		Inductance nH/m (Ref. Only)		Max. Recommended Lug Code
			single-layer braid	double-layer braid		single-layer braid	double-layer braid	single-layer braid	double-layer braid	single-layer braid	double-layer braid			
12	.24 (6.1)	.375 (9.5)	.056 (1.4)	.072 (1.8)	.75 (19.1)	.016 (.4)	.032 (.8)	48 (22)	24	9.0	18	1277	1260	B
20	.43 (10.9)	.375 (9.5)	.072 (1.8)	.086 (2.2)	.75 (19.1)	.016 (.4)	.032 (.8)	26 (19)	13	13.4	26.8	1170	1159	F
24	.52 (13.2)	.5 (12.7)	.072 (1.8)	.086 (2.2)	1.00 (25.4)	.016 (.4)	.032 (.8)	23 (18)	11.5	17.9	35.8	1116	1109	G
32	.76 (19.3)	.5 (12.7)	.102 (2.6)	.123 (3.1)	1.00 (25.4)	.021 (.5)	.042 (1.1)	13 (16)	6.5	35.8	71.6	1047	1040	G
40	.88 (22.4)	.5 (12.7)	.102 (2.6)	.123 (3.1)	1.00 (25.4)	.021 (.5)	.042 (1.1)	11 (15)	5.5	40.3	80.6	1034	1027	G
48	1.02 (25.9)	.5 (12.7)	.102 (2.6)	.123 (3.1)	1.00 (25.4)	.021 (.5)	.042 (1.1)	8 (14)	4	53.8	107.6	983	976	G
64	1.15 (29.2)	.5 (12.7)	.102 (2.6)	.123 (3.1)	1.00 (25.4)	.021 (.5)	.042 (1.1)	6 (12)	3	71.7	143.4	936	930	G

* Braid only, figures exclude termination lugs. **Test current is defined as the current required to reach 200° C at ambient temperature

GENERAL DUTY Series 107 Ground Straps



107-133 Five available materials • configurable soldered lugs



GENERAL DUTY GROUND STRAPS, SOLDERED LUGS

How To Order						
Sample Part Number	107-133	A	1000	E	H	-10 S
Product Series	General-duty ground strap, soldered lugs					
Braid Material Code	See Table I					
Size Code	See Table II					
Lug 1 Hole	See Table III (If specifying 2 different sizes, specify smaller hole as Lug 1)					
Lug 2 Hole	See Table III					
Length	In 1 inch increments. Measured when part is relaxed.					
Insulation	S = Insulated Sleeveing Omit for none					

Code	Braid Material
A	Copper / Tin Plated
B	Copper / Silver Plated
C	Copper / Nickel Plated
D	Stainless Steel
E	Nickel 200

Size Code	A	B	D	E	F	Available Lug Hole Codes
250	0.37 (9.4)	0.16 (4.1)	0.100 (2.5)	0.52 (4.0)	0.156	A
500	0.69 (17.5)	0.33 (8.4)	0.100 (2.5)	1.04 (8.0)	0.313	B – G
781	0.75 (19.1)	0.33 (8.4)	0.100 (2.5)	1.04 (8.0)	0.313	D – G
1000	0.88 (22.4)	0.39 (9.9)	0.100 (2.5)	1.17 (9.5)	0.375	E – H
1500	1.01 (25.7)	0.46 (11.7)	0.100 (2.5)	1.29 (11.1)	0.438	E – I
2000	1.29 (32.8)	0.61 (15.5)	0.100 (2.5)	1.61 (15.1)	0.594	F – K

Lug 1 & 2 Hole Size Code	C Dia.	Stud Size (Ref.)
A	.114 / .122 (2.9 / 3.1)	#4
B	.142 / .152 (3.6 / 3.9)	#6
C	.168 / .178 (4.3 / 4.5)	#8
D	.193 / .203 (4.9 / 5.2)	#10
E	.260 / .275 (6.6 / 7.0)	1/4
F	.323 / .338 (8.2 / 8.6)	5/16
G	.385 / .400 (9.8 / 10.2)	3/8
H	.448 / .463 (11.4 / 11.8)	7/16
I	.510 / .525 (13.0 / 13.3)	1/2
J	.573 / .588 (14.6 / 14.9)	9/16
K	.635 / .650 (16.1 / 16.5)	5/8

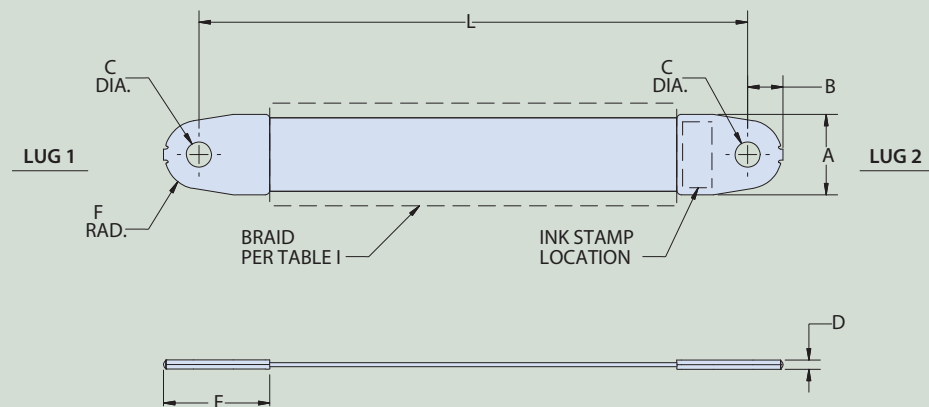

MATERIAL/FINISH

Lugs: Copper/Electroless Nickel plate

Sleeving: Viton M23053/13, Sumitomo FE3 or SM60. Meets outgassing requirements of NASA SP-R-0022A.

Solder: 97 Tin / 3 Copper

GENERAL DUTY Series 107 Ground Straps



107-197 Five available materials • configurable heavy-duty solder-free crimp lugs



GENERAL DUTY GROUND STRAPS, CRIMP LUGS

How To Order							
Sample Part Number	107-197	A	1000	E	H	-10	S
Product Series	General-duty ground strap, crimp lugs						
Braid Material Code	See Table I						
Size Code	See Table II						
Lug 1 Hole	See Table III (If specifying 2 different sizes, specify smaller hole as Lug 1)						
Lug 2 Hole	See Table III						
Length	In 1 inch increments. Tolerance $\pm .125$ for lengths up to 12" and $\pm 1\%$ for lengths greater than 12"						
Insulation	S = Insulated Sleeveing Omit for none						

Code	Braid Material
A	Copper / Tin Plated
B	Copper / Silver Plated
C	Copper / Nickel Plated
D	Stainless Steel
E	Nickel 200

Size Code	CSA (KCMIL)	A (Ref)	B	D (Ref)	E	Max. Lug Code
250	9.6	.41 (10.4)	.375 (9.5)	.09 (2.3)	.75 (19.1)	D
500	13.2	.60 (15.2)	.375 (9.5)	.08 (2.0)	.75 (19.1)	G
781	21.6	.75 (19.1)	.500 (12.7)	.10 (2.5)	1.00 (25.4)	H
1000	19.2	.86 (21.8)	.500 (12.7)	.10 (2.5)	1.00 (25.4)	I
1500	23.4	1.00 (25.4)	.500 (12.7)	.10 (2.5)	1.00 (25.4)	I
2000	28.8	1.25 (31.8)	.500 (12.7)	.10 (2.5)	1.00 (25.4)	I

Lug 1 & 2 Hole Size Code	C Dia.	Stud Size (Ref.)
A	.114 / .122 (2.9 / 3.1)	#4
B	.142 / .152 (3.6 / 3.9)	#6
C	.168 / .178 (4.3 / 4.5)	#8
D	.193 / .203 (4.9 / 5.2)	#10
E	.260 / .275 (6.6 / 7.0)	1/4
F	.323 / .338 (8.2 / 8.6)	5/16
G	.385 / .400 (9.8 / 10.2)	3/8
H	.448 / .463 (11.4 / 11.8)	7/16
I	.510 / .525 (13.0 / 13.3)	1/2

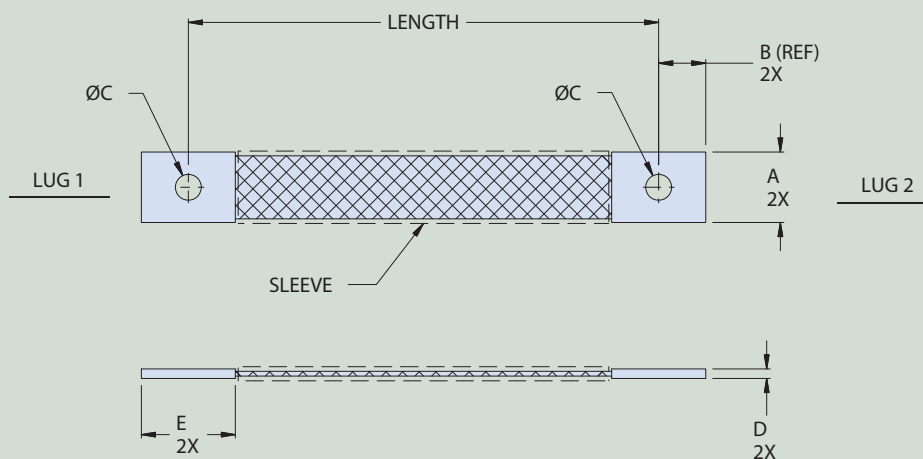

MATERIAL/FINISH

Braid: 36 AWG, see P/N development, Table I

Lugs: See P/N development, Table I

Sleeve: M23053/13, fluoroelastomer (Viton)

HEAVY DUTY Series 107 Ground Straps



Special 3-layer configuration • configurable heavy-duty solder-free crimp lugs

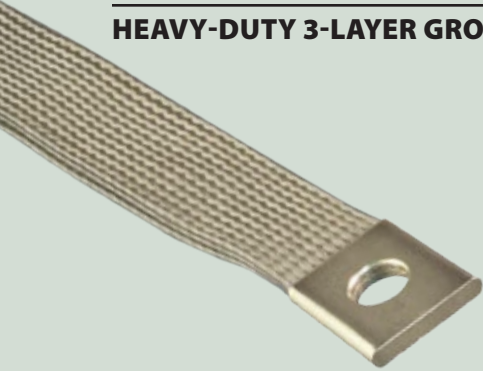

HEAVY-DUTY 3-LAYER GROUND STRAPS, CRIMP LUGS

How To Order				
Sample Part Number	107-159	-235	E	G S
Product Series	Special 3-layer ground strap			
Length	In millimeters. (eg. 235 = 235mm, 9.25 in.)			
Lug 1 Hole	See Table I (If specifying 2 different sizes, specify smaller hole as Lug 1)			
Lug 2 Hole	See Table I			
Insulation	S = Insulated Sleeving Omit for none			

Lug 1 & 2 Hole Size Code	A Dia.	Stud Size (Ref.)
A	.120/.128 (3.05/3.25)	#4
B	.147/.152 (3.73/3.86)	#6
C	.172/.180 (4.37/4.57)	#8
D	.199/.204 (5.05/5.18)	#10
E	.257/.266 (6.53/6.76)	1/4
F	.323/.328 (8.20/8.33)	5/16
G	.386/.391 (9.80/9.93)	3/8
H	.449/.454 (11.40/11.53)	7/16
J	.511/.517 (12.98/13.13)	1/2

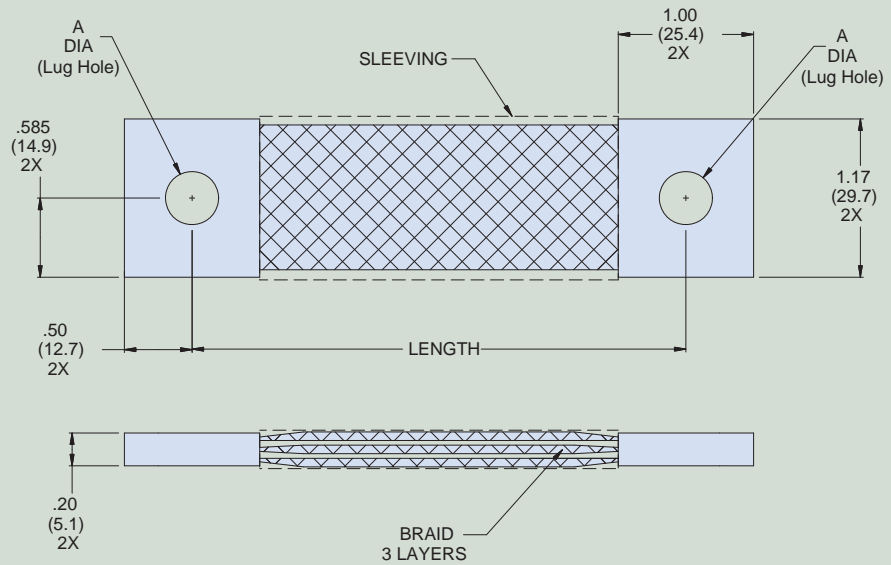

NOTES

Lug hole sizes may differ from each other depending on the part number development. The smaller lug hole diameter shall be specified in the "Lug 1" location in the part number. Length tolerance is $\pm .125$ inches (3.18mm) for lengths up to 12 inches, or $\pm 1\%$ for longer lengths.

MATERIAL/FINISH

Lugs: Copper per ASTM B152, ASTM F68, ASTM B75 or MIL-T-24107 / Tin Plate per ASTM B545 Class B or MIL-T-10727 Type I
Braid: Copper / tin plate IAW AA59569R30T0562
Sleeving: Viton M23053/13, Sumimark SM60

HARSH-ENVIRONMENT STAINLESS STEEL/NICKEL Qualified MIL-DTL-24749 Rev. C Type IV



Mil-qualified for shipboard applications



Glenair MIL-DTL-24749 Rev C Type IV ground straps solve harsh-environment shipboard corrosion and electrical resistance problems with a unique 50% Stainless Steel 316L / 50% Nickel 200 36AWG blend braid, and passivated Stainless Steel lugs. These US Navy-approved ground straps are qualified to the rigorous standards of M24749, and are tested beyond the mil-spec to survive 1000 hours salt spray. Allowed usages for Type IV straps can be found in MIL-STD-1310H.

- Meets the rigorous specifications of MIL-DTL-24749 Rev. C
- Tested to survive 1000 hours salt spray
- Unique Stainless Steel/Nickel hybrid braid
- Available in six standard configurations, with non-standard length/lug size configurations available

How To Order					
Sample Part Number	M24749	-IV	-B	-L	-H
Product Series	MIL-DTL-24749 Rev. C Type IV bond strap				
Bond Strap Type	IV = Flat CRES 316 / Nickel 200 braid with mounting lugs				
Standard Size Code	A = 6.0" length; .90" width, .406 H dia. D = 6.0" length; .90" width, .281 H dia. B = 12.0" length, .90" width, .406 H dia. E = 12.0" length, .90" width, .281 H dia. C = 18.0" length, .90" width, .406 H dia. F = 18.0" length, .90" width, .281 H dia. N = for non-standard sizes				
Non-Standard Length	Non-Standard length in inches (omit for standard sizes)				
Hole Diameter	For non-standard length Size Code N only: .406 = 13/32" hole diameter .282 = 9/32" hole diameter Omit for standard sizes				

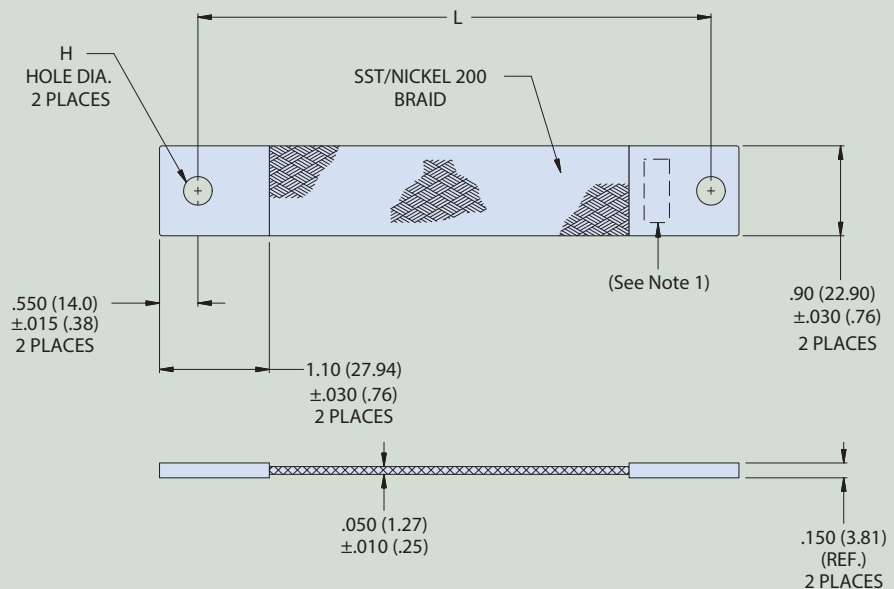

NOTES

1. Lugs are ink stamped or electro-etched per M24749 Rev. C Min. character height .06 (1.52)
2. Codes A – F are standard lengths. To order non-standard straps, enter Size Code **N**, enter **length** (in inches) in part number, and enter **0.406** or **0.281** for hole diameter.

MATERIAL/FINISH

Lugs - 316L Stainless Steel/Passivate
 Braid - 316L Stainless Steel 36 AWG, 50%; 200 Nickel 36 AWG, 50%



Glenair MIL-DTL-24749 Rev. C Type IV Stainless Steel/Nickel Ground Straps: US Navy qualified and tested to survive extreme environments

D

Swing-Arm 3-in-1 lightweight composite backshell with integrated EMI/RFI shield sock

319-180 standard entry

COMPOSITE BACKSHELL WITH SHIELD SOCK AND SELF-LOCKING ROTATABLE COUPLING NUT



		How To Order							
Sample Part Number		319	H	180	XB	15	B	R	14
Basic Part Number	319 - Swing-Arm backshell with shield sock								
Connector Designator	A = MIL-DTL-83723 Series 3 F = MIL-DTL-38999 Series I and II* H = MIL-DTL-38999 Series III & IV								
Basic Number	180								
Finish Symbol	See Table II								
Dash Number	See Dimensions Table I								
Optional Braid Material	See Table III. Omit for standard Nickel/Copper 34AWG								
Split Ring Option	R = Supplied with Split Ring (687-207) and Band (600-052). Omit for none.								
Custom Braid Length	Specify in Inches. Omit For Standard 12" Length								

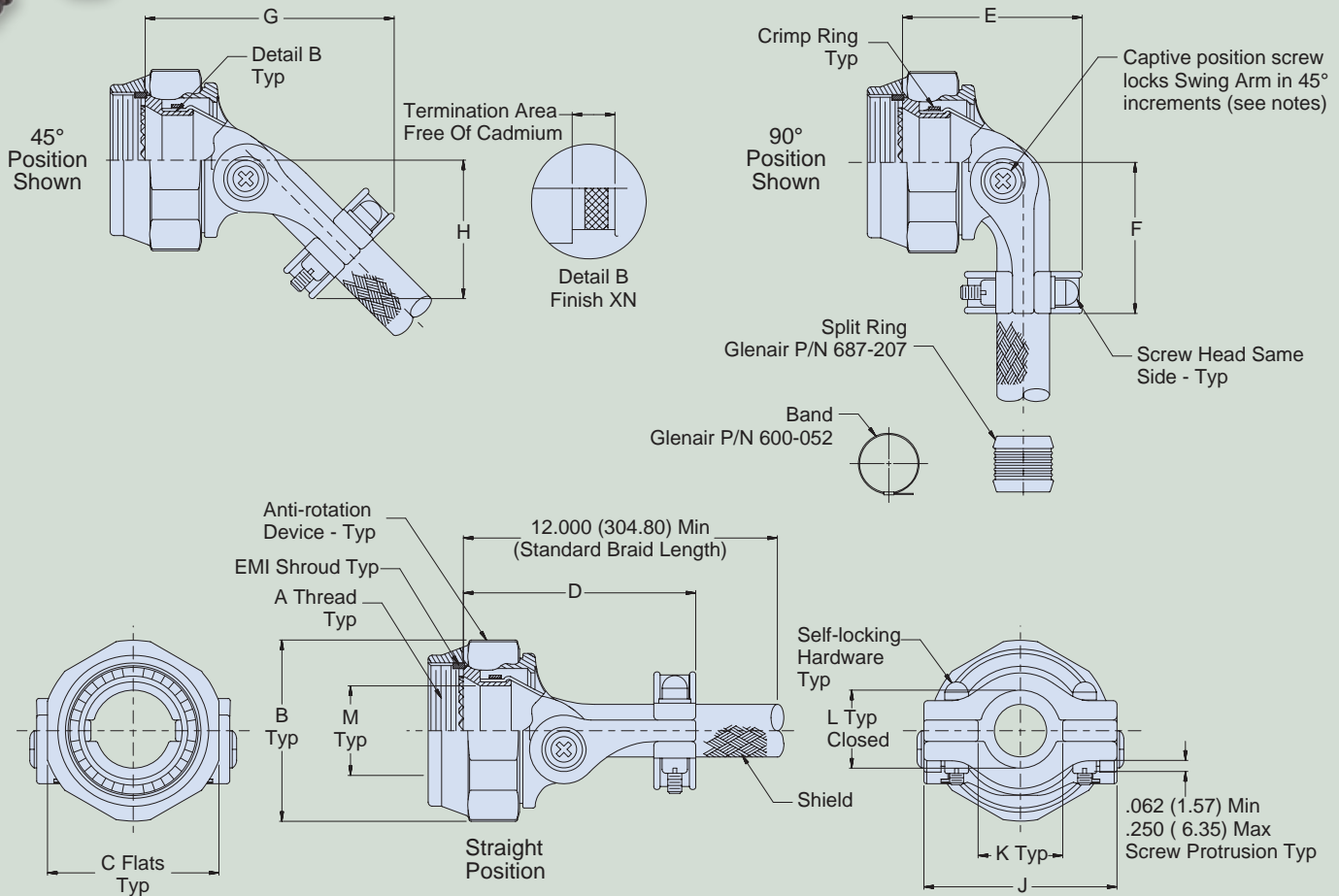

Swing-Arm 3-in-1 lightweight composite backshell with integrated EMI/RFI shield sock

319-180 standard entry

Connector Designator A			Connector Designator F			Connector Designator H			B Max Dia		C Flats			
Dash No.	Shell Size Ref	A Thread Class 2B	Dash No.	Shell Size Ref	A Thread Class 2B	Dash No.	Shell Size Ref	A Thread Iso Metric			Max		Min	
									In.	mm	In.	mm	In.	mm
08	08	1/2-20 UNF	08	08	7/16-28 UNEF	09	A	M12 x 1.0-6h	.812	20.6	.750	19.1	.736	18.7
10	10	5/8-24 UNEF	10	10	9/16-24 UNEF	11	B	M15 x 1.0-6H	.938	23.8	.875	22.2	.860	21.8
12	12	3/4-20 UNEF	12	12	11/16-24 UNEF	13	C	M18 x 1.0-6H	1.125	28.6	1.000	25.4	.980	24.9
14	14	7/8-20 UNEF	14	14	13/16-20 UNEF	15	D	M22 x 1.0-6H	1.250	31.8	1.125	28.6	1.100	27.9
16	16	1-20 UNEF	16	16	15/16-20 UNEF	17	E	M25 x 1.0-6H	1.375	34.9	1.250	31.8	1.224	31.1
18	18	1 1/16-18 UNEF	18	18	1 1/16-18 UNEF	19	F	M28 x 1.0-6H	1.500	38.1	1.375	34.9	1.348	34.2
20	20	1 3/16-18 UNEF	20	20	1 3/16-18 UNEF	21	G	M31 x 1.0-6H	1.625	41.3	1.500	38.1	1.469	37.3
22	22	1 5/16-18 UNEF	22	22	1 5/16-18 UNEF	23	H	M34 x 1.0-6H	1.750	44.5	1.625	41.3	1.581	40.2
24	24	1 7/16-18 UNEF	24	24	1 7/16-18 UNEF	25	J	M37 x 1.0-6H	1.875	47.6	1.750	44.5	1.690	42.9

Shell Size		D Max		E Max		F Max		G Max		H Max		J Max		K Min		L Max		M Diameter					
A, F	H																	A Code Min		F Code Min		H Code Min	
		In.	mm	In.	mm	In.	mm	In.	mm	In.	mm	In.	mm	In.	mm	In.	mm	In.	mm	In.	mm	In.	mm
08	09	1.50	38.1	.95	24.1	.84	21.3	1.43	36.3	.76	19.3	.98	24.9	.22	5.6	.265	6.7	.264	6.7	.264	6.7	.264	6.7
10	11	1.54	39.1	.99	25.1	.90	22.9	1.49	37.8	.82	20.8	1.05	26.7	.27	6.9	.310	7.9	.365	9.3	.392	10.0	.390	9.9
12	13	1.62	41.1	1.14	29.0	1.00	25.4	1.64	41.7	.92	23.4	1.2	30.5	.35	8.9	.390	9.9	.498	12.6	.506	12.9	.504	12.8
14	15	1.63	41.4	1.24	31.5	1.07	27.2	1.73	43.9	.98	24.9	1.3	33.0	.47	11.9	.506	12.9	.575	14.6	.631	16.0	.630	16.0
16	17	1.73	43.9	1.36	34.5	1.13	28.7	1.86	47.2	1.08	27.4	1.44	36.6	.55	14.0	.591	15.0	.700	17.8	.756	19.2	.756	19.2
18	19	1.88	47.8	1.46	37.1	1.20	30.5	1.93	49.0	1.12	28.4	1.56	39.6	.62	15.7	.661	16.8	.779	19.8	.844	21.4	.843	21.4
20	21	1.88	47.8	1.55	39.4	1.26	32.0	2.08	52.8	1.21	30.7	1.69	42.9	.70	17.8	.744	18.9	.904	23.0	.970	24.6	.969	24.6
22	23	1.91	48.5	1.63	41.4	1.33	33.8	2.15	54.6	1.27	32.3	1.77	45.0	.78	19.8	.826	21.0	1.029	26.1	1.094	27.8	1.091	27.7
24	25	1.94	49.3	1.70	43.2	1.40	35.6	2.23	56.6	1.33	33.8	1.89	48.0	.85	21.6	.896	22.8	1.144	29.1	1.219	31.0	1.217	30.9

Sym	Finish Description
XB	No Plating, Black
XM	Electroless Nickel
XMT	Ni-PTFE, Nickel-Fluorocarbon Polymer
XN	Selective Plating, Nickel & CAD O.D., See Detail B

Sym	Braid
A	100% AmberStrand®
B	75%/25% AmberStrand® Blend
(omit)	Standard Nickel/Copper 34 AWG
L	ArmorLite™
M	75%/25% ArmorLite™ Blend
T	Tin/Copper 34 AWG

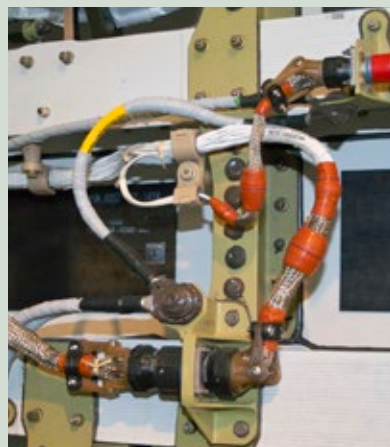

NOTES

- Glenair Series 600 Assembly Tools are recommended for assembly and installation.
- Swing arm locks in 45° increments, shell size 09 through 25. Additional positioning increments are manufacturer's option.
- Screw is captive to the arm when disengaged. When tightened, the screw will not protrude into the inside surfaces.
- *Add Mod Code **-475** to end of part number for use with Series II connector. Backshell to be supplied less shroud.
- Metric dimensions (mm) indicated in parentheses.

MATERIAL/FINISH:

Clamp body, coupling nut, saddles - High grade thermoplastic/See Table III.
 Clamp hardware - CRES/Passivate
 Crimp ring - Copper/Tin plated.

Swing-Arm 3-in-1 lightweight composite backshell with integrated EMI/RFI shield sock

319-181 wide mouth for larger diameter cables

WIDE MOUTH COMPOSITE BACKSHELL WITH SHIELD SOCK AND SELF-LOCKING ROTATABLE COUPLING NUT

		How To Order							
Sample Part Number		319	H	181	XB	15	B	R	14
Basic Part Number	319 - Swing-Arm backshell with shield sock								
Connector Designator	A = MIL-DTL-83723 Series 3 F = MIL-DTL-38999 Series I and II* H = MIL-DTL-38999 Series III & IV								
Basic Number	181								
Finish Symbol	See Table II								
Dash Number	See Dimensions Table I								
Optional Braid Material	See Table III. Omit for standard Nickel/Copper 34AWG)								
Split Ring Option	R = Supplied with Split Ring (687-207) and Band (600-052). Omit for none.								
Custom Braid Length	Specify in Inches. Omit For Standard 12" Length								

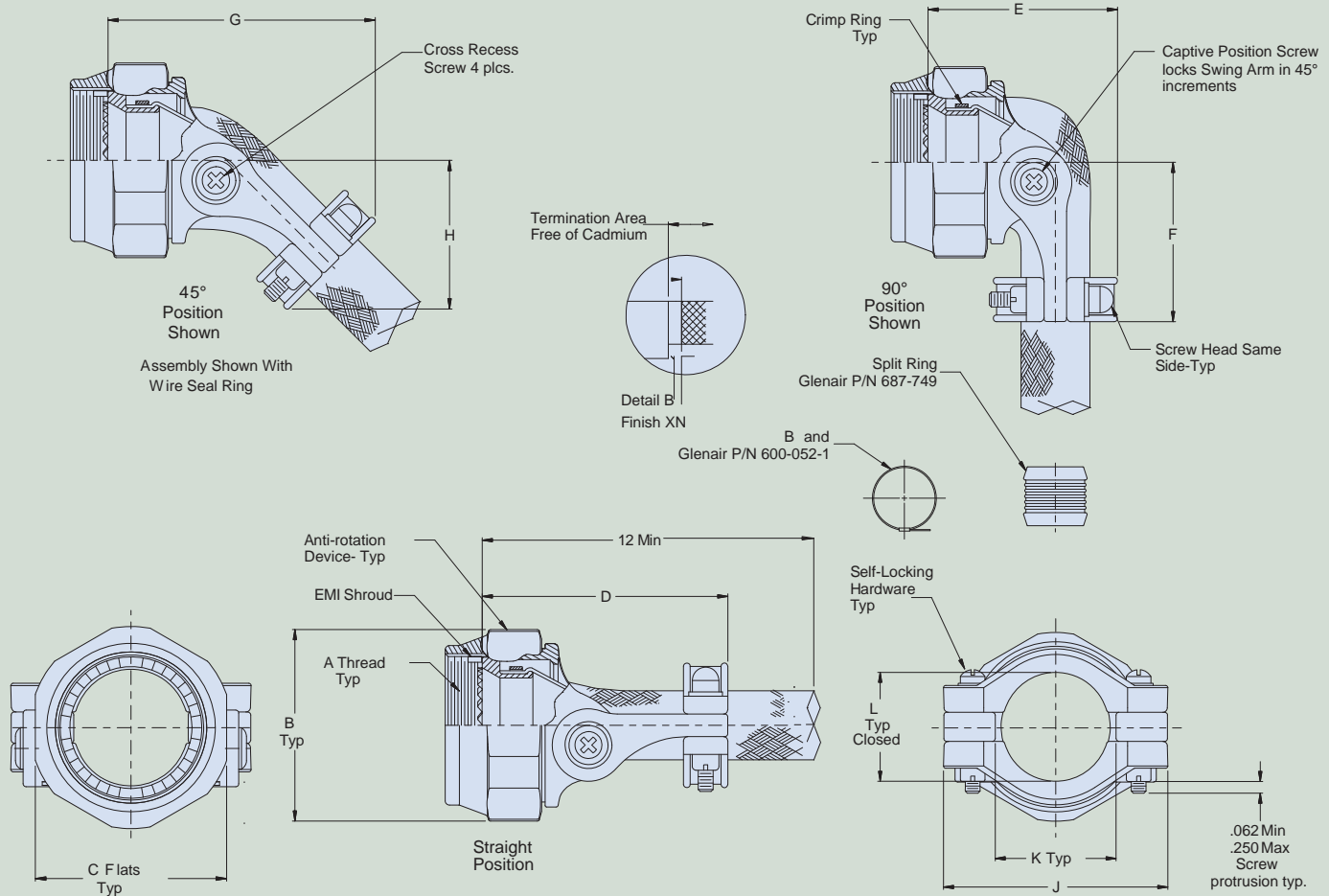

Swing-Arm 3-in-1 lightweight composite backshell with integrated EMI/RFI shield sock

319-181 wide mouth for larger diameter cables

Connector Designator A			Connector Designator F			Connector Designator H			B Max Dia		C Flats			
Dash No.	Shell Size Ref	A Thread Class 2B	Dash No.	Shell Size Ref	A Thread Class 2B	Dash No.	Shell Size Ref	A Thread Iso Metric	In.	mm	Max		Min	
											In.	mm	In.	mm
08	08	1/2-20 UNF	08	08	7/16-28 UNEF	09	A	M12 x 1.0-6H	.812	20.6	.750	19.1	.736	18.7
10	10	5/8-24 UNEF	10	10	9/16-24 UNEF	11	B	M15 x 1.0-6H	.938	23.8	.875	22.2	.860	21.8
12	12	3/4-20 UNEF	12	12	11/16-24 UNEF	13	C	M18 x 1.0-6H	1.125	28.6	1.000	25.4	.980	24.9
14	14	7/8-20 UNEF	14	14	13/16-20 UNEF	15	D	M22 x 1.0-6H	1.250	31.8	1.125	28.6	1.100	27.9
16	16	1-20 UNEF	16	16	15/16-20 UNEF	17	E	M25 x 1.0-6H	1.375	34.9	1.250	31.8	1.224	31.1
18	18	1 1/16-18 UNEF	18	18	1 1/16-18 UNEF	19	F	M28 x 1.0-6H	1.500	38.1	1.375	34.9	1.348	34.2
20	20	1 3/16-18 UNEF	20	20	1 3/16-18 UNEF	21	G	M31 x 1.0-6H	1.625	41.3	1.500	38.1	1.469	37.3
22	22	1 5/16-18 UNEF	22	22	1 5/16-18 UNEF	23	H	M34 x 1.0-6H	1.750	44.5	1.625	41.3	1.581	40.2
24	24	1 7/16-18 UNEF	24	24	1 7/16-18 UNEF	25	J	M37 x 1.0-6H	1.875	47.6	1.750	44.5	1.690	42.9

Shell Size		D Max		E Max		F Max		G Max		H Max		J ± .03		K Min		L Ref		M wire bundle dim. between ears ref.	
A, F	H	In.	mm	In.	mm	In.	mm	In.	mm	In.	mm	In.	mm	In.	mm	In.	mm	In.	mm
08	09	1.51	38.4	.98	24.9	.80	20.3	1.46	37.1	.78	19.8	.936	23.8	.350	8.9	.310	7.9	.393	10.0
10	11	1.58	40.1	1.05	26.7	.90	22.9	1.57	39.9	.87	22.1	1.172	29.8	.455	11.6	.375	9.5	.455	11.6
12	13	1.64	41.7	1.29	32.8	.97	24.6	1.76	44.7	1.02	25.9	1.406	35.7	.640	16.3	.594	15.1	.586	14.9
14	15	1.65	41.9	1.37	34.8	1.03	26.2	1.82	46.2	1.06	26.9	1.500	38.1	.710	18.0	.661	16.8	.710	18.0
16	17	1.74	44.2	1.44	36.6	1.10	27.9	1.92	48.8	1.12	28.4	1.562	39.7	.839	21.3	.713	18.1	.839	21.3
18	19	1.74	44.2	1.54	39.1	1.16	29.5	2.00	50.8	1.16	29.5	1.687	42.8	.922	23.4	.795	20.2	.934	23.7
20	21	1.89	48.0	1.69	42.9	1.23	31.2	2.18	55.4	1.29	32.8	1.912	48.6	1.068	27.1	.996	25.3	1.068	27.1
22	23	1.92	48.8	1.76	44.7	1.30	33.0	2.25	57.2	1.35	34.3	2.036	51.7	1.197	30.4	1.060	26.9	1.197	30.4
24	25	2.08	52.8	1.79	45.5	1.49	37.8	2.39	60.7	1.47	37.3	2.281	57.9	1.323	33.6	1.123	28.5	1.323	33.6

Sym	Finish Description
XB	No Plating, Black
XM	Electroless Nickel
XMT	Ni-PTFE, Nickel-Fluorocarbon Polymer
XN	Selective Plating, Nickel & CAD O.D., See Detail B

Sym	Braid
A	100% AmberStrand®
B	75%/25% AmberStrand® Blend
(omit)	Standard Nickel/Copper 34 AWG
L	ArmorLite™
M	75%/25% ArmorLite™ Blend
T	Tin/Copper 34 AWG

NOTES

- Glenair Series 600 Assembly Tools are recommended for assembly and installation.
- Swing arm locks in 45° increments, shell size 09 through 25. Additional positioning increments are manufacturer's option.
- Screw is captive to the arm when disengaged. When tightened, the screw will not protrude into the inside surfaces.

MATERIAL/FINISH:

Clamp body, coupling nut, saddles - High grade thermoplastic/See Table III.

EMI/RFI Adapter - Brass

Anti-rotation device - corrosion-resistant material

Shield - Copper/nickel plate

Interface ring and shroud - see Table II

Crimp ring - Copper/Tin plated.

Lightweight composite shrink boot adapter with integrated EMI/RFI shield sock

319-155

COMPOSITE SHRINK BOOT ADAPTER WITH SHIELD SOCK AND SELF-LOCKING ROTABLE COUPLING NUT

How To Order											
Sample Part Number	319	H	S	155	XB	16	B	-D	T	R	14
Basic Part Number	319 - Straight shrink boot adapter with shield sock										
Connector Designator	A = MIL-DTL-83723 Series 3 F = MIL-DTL-38999 Series I and II* H = MIL-DTL-38999 Series III & IV										
Angle	S = Straight										
Basic Number	155										
Finish Symbol	See Table II										
Shell Size	See Dimensions Table I										
Optional Braid Material	See Table III. Omit for standard Nickel/Copper 34AWG										
Drain Holes	D = With drain holes. Omit for none										
Shrink Boot	T = Supplied with shrink boot. Omit for none										
Split Ring Option	R = Supplied with Split Ring (687-207) and Band (600-052). Omit for none.										
Custom Braid Length	Specify in Inches. Omit For Standard 12" Length										

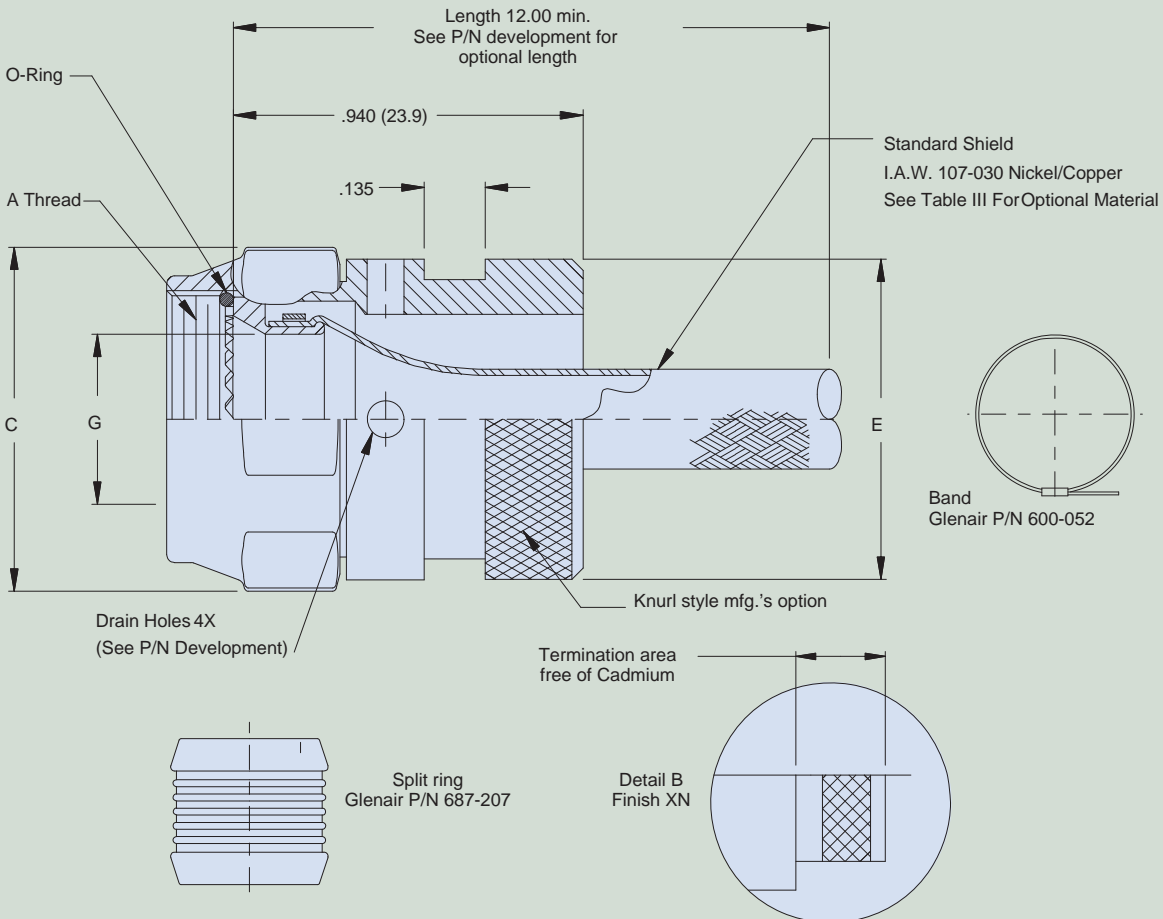

Lightweight composite shrink boot adapter with integrated EMI/RFI shield sock



319-155

Table I								
Connector Designator A			Connector Designator F			Connector Designator H		
Dash No.	Shell Size Ref	A Thread Class 2B	Dash No.	Shell Size Ref	A Thread Class 2B	Dash No.	Shell Size Ref	A Thread Iso Metric
08	08	1/2-20 UNF	08	08	7/16-28 UNEF	09	A	M12 x 1.0-6H
10	10	5/8-24 UNEF	10	10	9/16-24 UNEF	11	B	M15 x 1.0-6H
12	12	3/4-20 UNEF	12	12	11/16-24 UNEF	13	C	M18 x 1.0-6H
14	14	7/8-20 UNEF	14	14	13/16-20 UNEF	15	D	M22 x 1.0-6H
16	16	1-20 UNEF	16	16	15/16-20 UNEF	17	E	M25 x 1.0-6H
18	18	1 1/16-18 UNEF	18	18	1 1/16-18 UNEF	19	F	M28 x 1.0-6H
20	20	1 3/16-18 UNEF	20	20	1 3/16-18 UNEF	21	G	M31 x 1.0-6H
22	22	1 5/16-18 UNEF	22	22	1 5/16-18 UNEF	23	H	M34 x 1.0-6H
24	24	1 7/16-18 UNEF	24	24	1 7/16-18 UNEF	25	J	M37 x 1.0-6H

Table I (continued)												
B Dia Ref.		C Flats				E Max		G Dia				Shrink Boot
In.	mm	Max		Min		In.	mm	Code H and F		Code A		
		In.	mm	In.	mm			In.	mm	In.	mm	
.812	20.6	.750	19.1	.736	18.7	.533	13.5	.750	19.1	.736	18.7	770-003S102
.938	23.8	.875	22.2	.860	21.8	.605	15.4	.875	22.2	.860	21.8	770-003S103
1.125	28.6	1.000	25.4	.980	24.9	.774	19.7	1.000	25.4	.980	24.9	770-003S103
1.250	31.8	1.125	28.6	1.100	27.9	.838	21.3	1.125	28.6	1.100	27.9	770-003S103
1.375	34.9	1.250	31.8	1.224	31.1	.963	24.5	1.250	31.8	1.224	31.1	770-003S104
1.500	38.1	1.375	34.9	1.348	34.2	1.042	26.5	1.375	34.9	1.348	34.2	770-003S104
1.625	41.3	1.500	38.1	1.469	37.3	1.217	30.9	1.500	38.1	1.469	37.3	770-003S106
1.750	44.5	1.625	41.3	1.581	40.2	1.355	34.4	1.625	41.3	1.581	40.2	770-003S107
1.875	47.6	1.750	44.5	1.690	42.9	1.443	36.7	1.750	44.5	1.690	42.9	770-003S107

Table II - Finish	
Sym	Finish Description
XB	No Plating, Black
XD	No Plating, Desert Tan

Table III - Braid Material	
Sym	Braid
A	100% AmberStrand®
B	75%/25% AmberStrand® Blend
(omit)	Standard Nickel/Copper 34 AWG
L	ArmorLite™
M	75%/25% ArmorLite™ Blend
T	Tin/Copper 34 AWG

NOTES

- Assembly to be identified with manufacturer's name and part number as space permitted
 Glenair 600 series backshell assembly tools are recommended for assembly and installation.
 O-Ring supplied with connector designator F & H only
 O-Ring not supplied with connector designator A or with drain hole option
 Material/Finish:
- Coupling Nut, Adapter and Split Ring: High Temperature Engineering Thermoplastic (see Table II)
 - Follower: Brass/Electroless Nickel
 - O-Ring: Fluorosilicone/NA
 - Shrink Boot: see 770-001S** See Shrink Boot Product Page for Details
 - Band: SST/Passivated
 - Crimp Ring: Copper/Tin Plated
 - Braid: See Table III

Lightweight composite environmental piggyback shrink boot adapter with integrated EMI/RFI shield sock

319-183

FAST AND EASY FINAL INSTALLATION OF ENVIRONMENTAL BOOTS TO SHIELD SOCK ASSEMBLIES



Cutaway View

How To Order	
Sample Part Number	319 H S 183 XM 19 B -2
Basic Part Number	319 - Piggyback boot adapter
Connector Designator	A = MIL-DTL-83723, Series III, MIL-DTL-5015, MIL-DTL-26482 F = MIL-DTL-38999, Series I & II G = MIL-DTL-28840 H = MIL-DTL-38999, Series III & IV U = MIL-DTL-29600
Angle	S = Straight T = 45° Elbow W = 90° Elbow
Basic Number	183
Finish Symbol	See Table II
Shell Size	See Dimensions Table III
Optional Braid Material	See Table V. Insert dash (-) for standard Nickel/Copper 34AWG
Boot Material	See Table IV

Sym	Finish Description
XM	2000 Hour Corrosion Resistant Electroless Nickel
XMT	2000 Hour Corrosion Resistant NI-PTFE, Nickel-Fluorocarbon Polymer
XW	2000 Hour Corrosion Resistant Cadmium Olive Drab Over Electroless Nickel

Symbol	Braid Type
A	100% AmberStrand®
B	75%/25% AmberStrand® Blend
-	Nickel/Copper 34 AWG
T	Tin/Copper 34 AWG
L	Armorlite™
M	75%/25% ArmorLite™ Blend

Attribute	Type 1 High-Performance Semi-Rigid Elastomer	Type 2 Zero-Halogen Semi-Rigid Polyolefin	Type 3 General Purpose Flexible Polyolefin
Continuous Operating Temp.	-75° To +150° c-	30° To +135° c-	55° To 135° c
Resistance To Fuels, Oils	Excellent	Very Good	Good
Low Toxicity, Zero Halogen	No	Yes	No

MATERIAL / FINISH

Elbow, adapter: - High-grade engineering thermoplastic/see Table II
Coupling nut, anti-decoupling device: high-grade engineering thermoplastic
O-ring: silicone
Braid: see table V
Boot: see table IV
Band: CRES

ASSEMBLY NOTES

Glenair 600-091 or 600-157 Series Backshell Assembly Tools are recommended for assembly and installation.
O-Ring supplied with Connector Designator F & H only.
O-Ring not supplied with Connector Designator A.

Lightweight composite environmental piggyback shrink boot adapter with integrated EMI/RFI shield sock

319-183

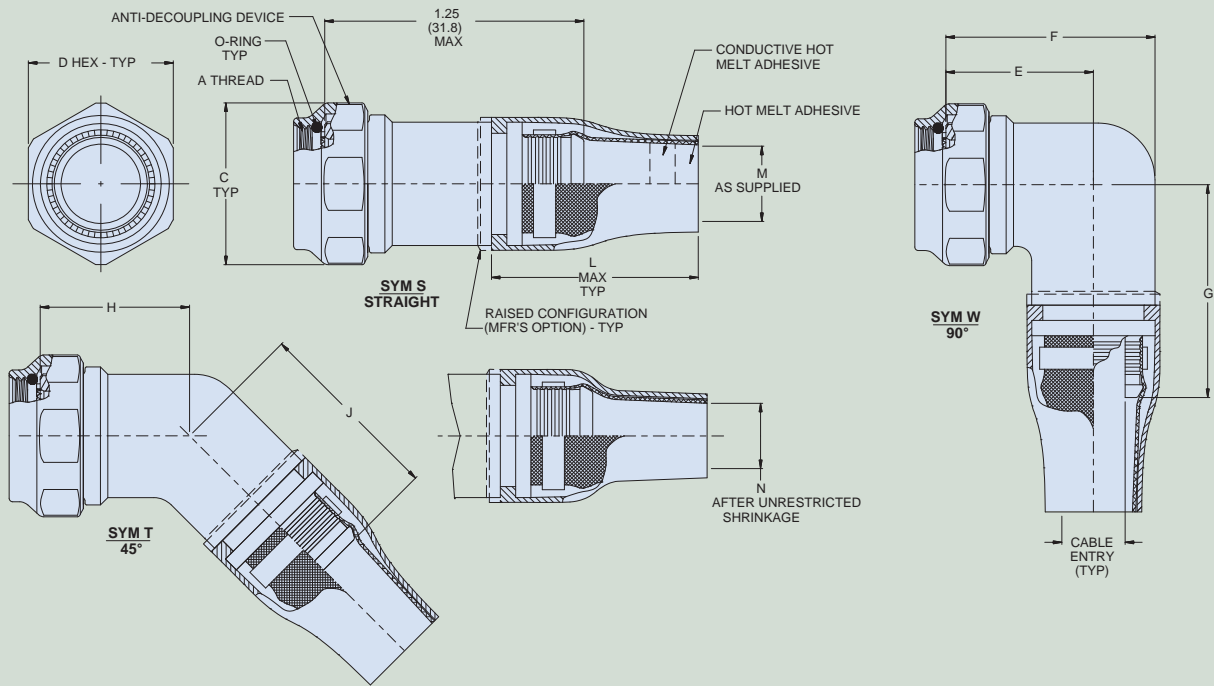

Table III: Shell Size

Shell Size					A Thread	Ø C Max		D Flats		E .060 (1.5)		F .090 (2.3)		G .090 (2.3)		H .060 (1.5)		J .090 (2.3)		Cable Entry ± .03 (0.8)		L Max		M Min		N Max	
A	F/L	G	H	U		In.	mm	In.	mm	In.	mm	In.	mm	In.	mm	In.	mm	In.	mm	In.	mm	In.	mm	In.	mm	In.	mm
-	08	-	-	-	7/16-28 UNEF	.860	21.8	.750	19.1	.690	17.5	.880	22.4	1.19	30.2	.720	18.3	1.00	25.4	.250	6.40	2.36	59.9	0.26	6.60	.138	3.51
08	-	-	-	09	M12 X 1-6H	-	-	-	-	-	-	-	-	-	-	-	-	-	-	-	-	-	-	-	-	-	-
-	-	-	-	-	1/2-20 UNEF	-	-	-	-	-	-	-	-	-	-	-	-	-	-	-	-	-	-	-	-	-	-
03	10	-	-	-	9/16-24 UNEF	.980	24.9	.880	22.4	.750	19.1	1.00	25.4	1.25	31.8	.750	19.1	1.06	26.9	.380	9.70	2.36	59.9	0.38	9.70	.197	5.00
-	-	-	-	11	M15 X 1-6H	-	-	-	-	-	-	-	-	-	-	-	-	-	-	-	-	-	-	-	-	-	-
10	-	-	-	-	5/8-24 UNEF	-	-	-	-	-	-	-	-	-	-	-	-	-	-	-	-	-	-	-	-	-	-
-	-	-	-	10	5/8-28 UN	-	-	-	-	-	-	-	-	-	-	-	-	-	-	-	-	-	-	-	-	-	-
-	12	-	-	-	11/16-24 UNEF	1.16	29.5	1.00	25.4	.810	20.6	1.13	28.7	1.31	33.3	.750	19.1	1.13	28.7	.500	12.7	2.83	71.9	0.51	13.0	.197	5.00
-	-	-	-	13	M18 X 1-6H	-	-	-	-	-	-	-	-	-	-	-	-	-	-	-	-	-	-	-	-	-	-
12	-	11	-	-	3/4-20 UNEF	-	-	-	-	-	-	-	-	-	-	-	-	-	-	-	-	-	-	-	-	-	-
-	-	-	-	12	3/4-28 UNS	-	-	-	-	-	-	-	-	-	-	-	-	-	-	-	-	-	-	-	-	-	-
-	14	-	-	-	13/16-20 UNEF	1.28	32.5	1.13	28.7	.880	22.4	1.31	33.3	1.38	35.1	.760	19.3	1.16	29.5	.630	16.0	2.83	71.9	0.63	16.0	.236	5.60
-	-	-	-	15	M22 X 1-6H	-	-	-	-	-	-	-	-	-	-	-	-	-	-	-	-	-	-	-	-	-	-
14	-	13	-	-	7/8-20 UNEF	-	-	-	-	-	-	-	-	-	-	-	-	-	-	-	-	-	-	-	-	-	-
-	-	-	-	14	7/8-28 UNEF	-	-	-	-	-	-	-	-	-	-	-	-	-	-	-	-	-	-	-	-	-	-
-	16	-	-	-	15/16-20 UNEF	1.41	35.8	1.25	31.8	.940	23.9	1.38	35.1	1.44	36.6	.780	19.8	1.18	30.0	.750	19.1	3.74	95.0	0.76	19.3	.236	5.60
-	-	-	-	17	M25 X 1-6H	-	-	-	-	-	-	-	-	-	-	-	-	-	-	-	-	-	-	-	-	-	-
16	-	15	-	-	1-20 UNEF	-	-	-	-	-	-	-	-	-	-	-	-	-	-	-	-	-	-	-	-	-	-
-	-	-	-	16	1-28 UN	-	-	-	-	-	-	-	-	-	-	-	-	-	-	-	-	-	-	-	-	-	-
18	18	-	-	-	1 1/16-18 UNEF	1.52	38.6	1.38	35.1	.970	24.6	1.44	36.6	1.47	37.3	.790	20.1	1.19	30.2	.810	20.6	3.74	95.0	0.82	20.8	.276	7.01
-	-	-	-	19	M28 X 1-6H	-	-	-	-	-	-	-	-	-	-	-	-	-	-	-	-	-	-	-	-	-	-
-	-	-	-	17	1 1/8-18 UNEF	-	-	-	-	-	-	-	-	-	-	-	-	-	-	-	-	-	-	-	-	-	-
20	-	-	-	18	1 1/8-28 UNEF	-	-	-	-	-	-	-	-	-	-	-	-	-	-	-	-	-	-	-	-	-	-
-	20	-	-	-	1 3/16-18 UNEF	1.64	41.7	1.50	38.1	1.06	26.9	1.63	41.4	1.56	39.6	.820	20.8	1.22	31.0	.940	23.9	3.74	95.0	0.94	23.9	.335	8.51
-	-	-	-	21	M31 X 1 6H	-	-	-	-	-	-	-	-	-	-	-	-	-	-	-	-	-	-	-	-	-	-
-	-	19	-	-	1 1/4-18 UNEF	-	-	-	-	-	-	-	-	-	-	-	-	-	-	-	-	-	-	-	-	-	-
22	22	-	-	-	1 1/4-28 UNEF	-	-	-	-	-	-	-	-	-	-	-	-	-	-	-	-	-	-	-	-	-	-
-	-	-	-	20	1 5/16-18 UNEF	1.77	45.0	1.63	41.4	1.13	28.7	1.75	44.5	1.63	41.4	.860	21.8	1.26	32.0	1.06	26.9	4.92	125	1.07	27.2	.394	10.0
-	-	-	-	23	M34 X 1-6H	-	-	-	-	-	-	-	-	-	-	-	-	-	-	-	-	-	-	-	-	-	-
-	-	-	-	22	1 3/8-28 UN	-	-	-	-	-	-	-	-	-	-	-	-	-	-	-	-	-	-	-	-	-	-
24	24	23	-	-	1 7/16-18 UNEF	1.89	48.0	1.75	44.5	1.19	30.2	1.88	47.8	1.69	42.9	.890	22.6	1.29	32.8	1.19	30.2	4.92	125	1.19	30.2	.394	10.0
-	-	-	-	25	M37 X 1-6H	-	-	-	-	-	-	-	-	-	-	-	-	-	-	-	-	-	-	-	-	-	-
61	-	-	-	-	1 1/2-18 UNEF	-	-	-	-	-	-	-	-	-	-	-	-	-	-	-	-	-	-	-	-	-	-
-	-	-	-	24	1 1/2-28 UN	-	-	-	-	-	-	-	-	-	-	-	-	-	-	-	-	-	-	-	-	-	-
-	-	25	-	-	1 9/16-18 UNEF	2.02	51.3	1.88	47.8	1.34	34.0	2.13	54.1	1.78	45.2	.920	23.4	1.32	33.5	1.38	35.1	4.92	125	1.38	35.1	.591	15.0
28	-	-	-	-	1/34-18 UNS	2.15	54.6	2.00	50.8	-	-	-	-	-	-	-	-	-	-	-	-	-	-	-	-	-	-

D

BAND-MASTER ATS® EMI/RFI Shield Termination System



The advanced termination system
for interconnect cable shielding



- Fast, cost-effective cable shielding termination
- Integrated digital counter aids in identifying calibration intervals
- Precision hand-held tool and bands deliver reliable, repeatable performance
- Single-piece stainless steel bands in various sizes and lengths
- Clamp both small and large diameters easily and reliably
- Pneumatic banding tool for high-speed mass production
- Qualified for both military and commercial programs

Band-Master ATS® provides quick, easy, cost-effective and reliable termination of braided shielding to connectors and backshells.

Band-Master ATS® is the advanced termination system for interconnect cable shielding. The unique low profile and smooth inside diameter of the one-piece stainless steel clamping band virtually eliminates RFI/EMI/EMP leakage paths. The lock maintains constant tension under extreme environmental conditions. Band-Master ATS® bands pass severe shock, vibration and thermal cycle testing with negligible deterioration of shell conductivity.



Band-Master™ ATS Manual Tool Selection

601-100	601-101	601-108	601-109
for Standard .24"W Bands Tension range 100 to 180 lbs. Calibrate at 150 lbs. ± 5 lbs.	for .12"W Micro Bands Tension range 50 to 85 lbs. Calibrate at 80 lbs ±5 lbs.	for .075"W Nano Bands Tension range 20 to 50 lbs. Calibrate at 50 lbs. ± 3 lbs.	for 24"W Slim Standard Bands Tension range 50 to 100 lbs. Calibrate at 100 lbs. ± 5 lbs.

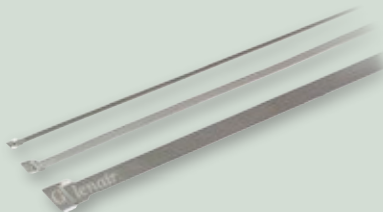

3 lengths and 3 widths of EMI braid termination bands plus new slim standard bands for size and weight savings—50% lighter and lower-profile than standard bands.

Band-Master™ ATS Band Selection

Bands	Length		Part Number		Fits Diameter	
	in.	mm.	Flat	Pre-Coiled	in.	mm.
Short Standard Band	9.0	228.6	601-005	601-006	1.0	25.4
Medium Standard Band	14.25	361.95	601-040	601-041	1.8	45.7
Long Standard Band	18.0	457.2	601-049	601-050	2.5	63.5
Short Micro Band	5.0	127.0	601-024	601-025	0.5	12.7
Medium Micro Band	8.125	206.38	601-060	601-061	.88	22.4
Long Micro Band	14.25	361.95	601-064	601-065	1.8	45.7
Short Nano Band	6.0	152.4	601-500	601-501	.60	15.2
Medium Nano Band	9.0	228.6	601-504	601-505	.94	23.9
Long Nano Band	14.0	355.6	601-508	601-509	1.8	45.7
Short Slim Standard Band	9.0	228.6	601-570	601-571	.94	23.9
Medium Slim Standard Band	14.25	361.95	601-572	601-573	1.8	45.7

Utilizing ArmorLite™ pull-over braid

TOOLS AND MATERIALS:

- ArmorLite™ Braid (P/N 103-051)
- Split Rings
- Banding Straps
- Band-Master ATS® Hand Banding Tool
- Lace tie



Step 1: Place split rings onto assembly—two on the main leg and one on the breakout leg.



Step 2: Install a length of ArmorLite™ over the breakout leg. Flare the braid material out and over the main leg of the assembly and over the adjacent split ring. Spot tie in place.

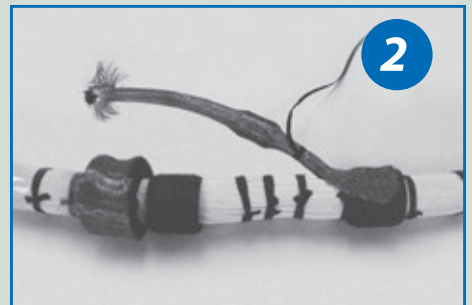

Step 3: Position two separate lengths of ArmorLite™ on either side of the breakout and over the main leg of the assembly. Make a 2-inch cut in each respective length and overlap both pieces to surround the breakout leg and amply cover both split rings.

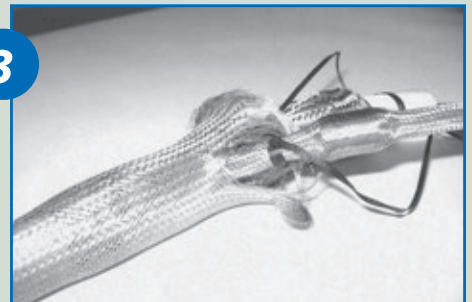
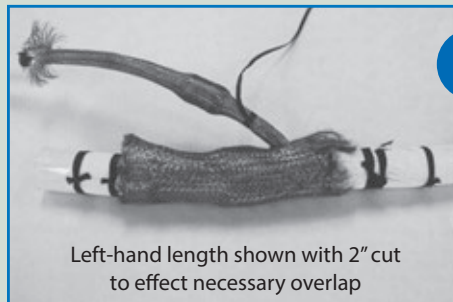

Step 4: Use lacing ties to secure all braid in place.



Step 5: Install a Band-Master ATS® Band over each termination area, exactly centered on split support rings.

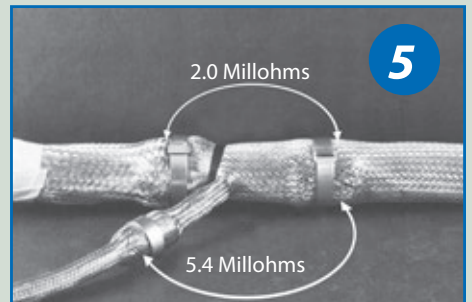

IMPORTANT: Always roll band through the buckle slot twice (see coiled band in photo above). Bands must be double-coiled to function correctly. All Band-Master ATS® bands are available pre-coiled.

Shield Termination Assembly Procedure

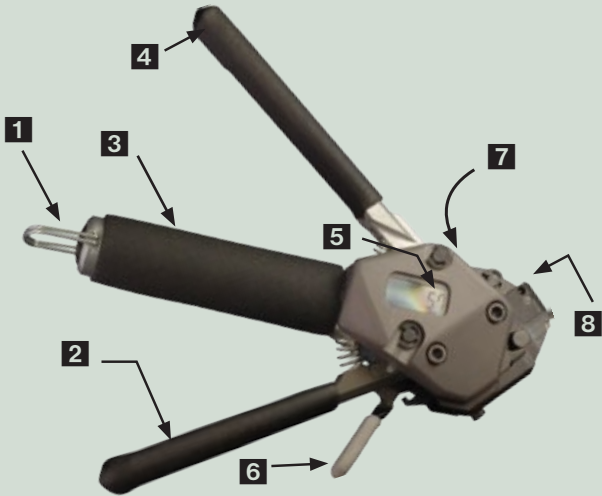

- 1 Calibration Access Plug**
- 2 Tensioning Lever:**
Squeeze with short gentle strokes to tighten band to the proper tension. Lever will lock to
- 3 Handle** with final full stroke.
- 4 Cut-Off Lever:**
Squeeze to lock band buckle and trim excess band material.
- 5 Calibration Counter**
- 6 Band Insertion and Release Lever:**
Depress lever to insert or release band from tool.
- 7 Serial Number**
- 8 Tension Release Lever**

NOTES:
 1. Use only genuine Band-Master™ ATS bands. Other manufacturer's bands may damage tool.
 2. Use only .240" wide bands with 601-100 tool and .120" wide bands with 601-101 tool.

Step 1

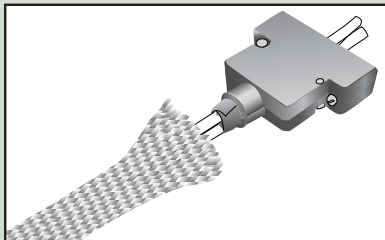

Prepare Cable Braid for termination process
NOTE: Complete banding on an unfixtured cable assembly. Terminating a band to a clamped or fixtured cable will affect the applied forces and interfere with the cut-off operation. The cut-off operation causes a rotation of the band termination in order to lock the band.

Step 2

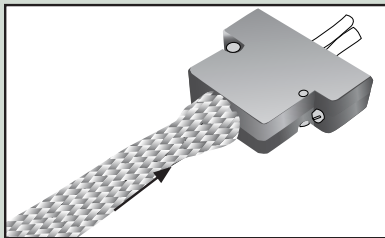

Push braid forward over banding platform. Milk braid as required to remove slack and ensure a snug fit around the shield termination area.

Step 3

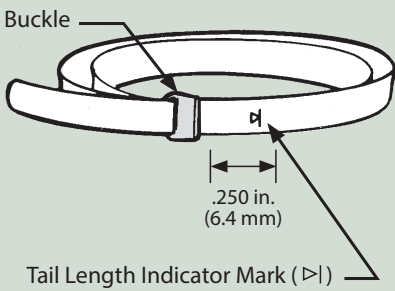

Double-coil the band prior to use:
IMPORTANT: Due to connector/adaptor circumference, it may be necessary to double-coil the band in place around the cable or termination area.
 A. Loop/insert the leading edge of band through the buckle slot twice. (Bands must be double-coiled.)
 B. Tighten the coil until the indicator mark (▷) is approximately .250 inches (6.4) shy of the buckle slot (see illustration at left). This will ensure sufficient band tail length for insertion into tool.

Step 4

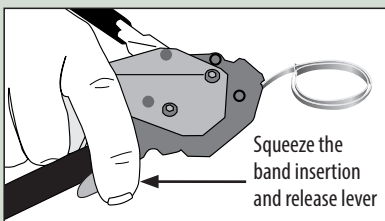

Depress the band insertion and release lever (6), and insert the working end of the band into the front end opening of the tool, with the loop positioned outward as shown.

Shield Termination Assembly Procedure (continued)

Step 5

The band termination area on all backshells is wider than the band. Position the band near the rear lip of the banding platform, allowing room for the buckle. For elliptical cable entries position the buckle off center of the peak of the circle. Failure to follow these guidelines will result in poor performance.

Position the band near the rear lip leaving room for buckle.

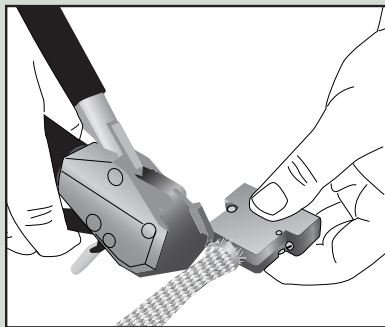
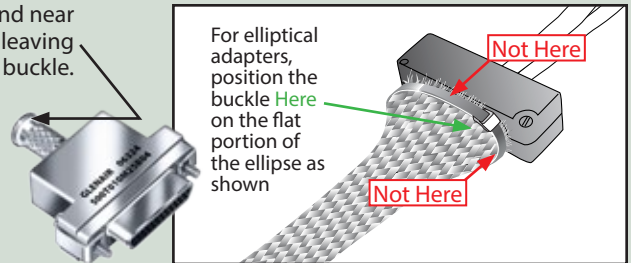

Step 6

Contract the band with the tensioning lever (2) using short, even strokes. As the band contracts firmly on the termination area, pull a full stroke to lock the lever against the main tool handle which will indicate the band is compressed to the proper tension.

NOTE: *Overly rapid tightening of the band may result in uneven compression. If alignment of the band and shield is unsatisfactory, tension can be relaxed by pulling up on the tensioning lever (2) and then pushing the tension release lever (8) forward. Make adjustments as necessary and finish tightening with tensioning lever (2) as described above. Instructional videos are available at www.glenair.com/banding/*

Step 7

Complete the clamping process by depressing the cut-off lever (4), allowing band and cable to rotate slightly. Pull up the release lever (6) to remove excess band for disposal.

NOTE: *Always band on an unfixtured connector/cable assembly.*

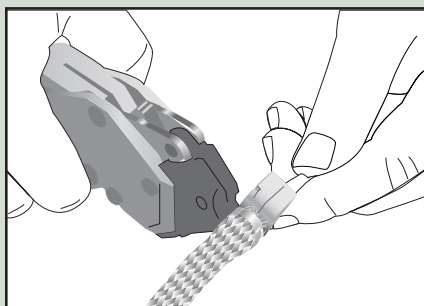

Step 8

Trim away excess braid from the forward groove, particularly if a shrink boot is to be applied to the assembly.

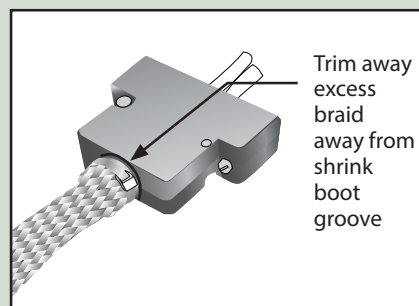

Step 9

Visually inspect shield termination for problems.

NOTE: *Band can be removed by lifting the buckle with a screwdriver or diagonal cutters.*

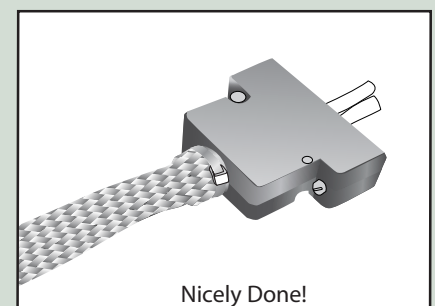

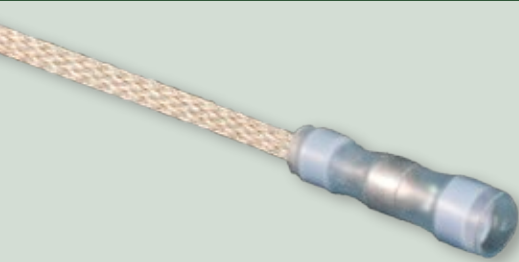

How To Order				
Sample Part Number	077-030	03	T	-6
Product Series	HST sleeve with pre-installed braid			
Size and Braid Material Type	See Tables I, II, and IV			
Thermal Indicator	T = with indicator Omit for none			
Braid Length	-6 = 6 inches, standard. Longer lengths available in 2" increments (-8, -10, -12...-24 [maximum 24"])			

- Designed to meet SAE AS83519 performance requirements
- Fabricated from transparent cross-linked polyvinylidene fluoride tubing for optimal environmental shield termination
- Pre-fluxed solder preform and thermally stabilized thermoplastic sealing rings to encapsulate and protect the shield-to-ground termination
- -55°C to 125°C temperature range IAW SAE AS83519

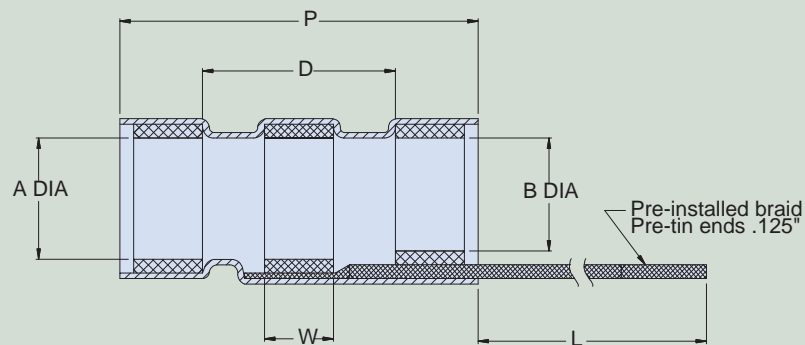

For best results prepare cable as shown

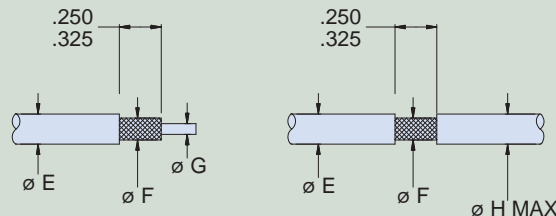

MATERIAL/FINISH:

- Insulation sleeve - Heat-shrinkable, radiation crosslinked, modified polyvinylidene fluoride per MIL-I-23053/8. Color - Translucent blue.
- Sealing ring - Thermally stabilized thermoplastic. Color - blue.
- Solder - Sn63 per ANSI-J-STD-006.
- Flux - ROM1 per ANSI-J-STD-004 (to be used on nickel plated shields only).
- Optional thermal indicator - changes from color to colorless.

APPLICATION:

- Temperature rating, Table I, III, IV: -55°C to +150°C, Cable jacket rating - 125° Min.
- Temperature rating, Table II: -55°C to +175°C, Cable jacket rating - 150° Min.
- Shield plating, Table I, IV: Tin or silver.
- Shield plating, Table II: Nickel.

077-030 Pre-installed braid pre-tinned on both ends

TABLE I: Tin Copper Braid per A-A-59569 Dimensions, Marking Code and Braid Information

Size	A Dia Min	B Dia Min	P ± .07 (1.8)	D Min	W Ref	L Min	SnCu Braid 36 AWG Ref 101-004	Marking Code	E Dia Max	F Dia Min	G Dia Min	H Dia Max
01	.105 (2.67)	.075 (1.91)	.65 (16.5)	.325 (8.26)	.095 (2.42)	6.00 (152.4)	101-004-062-36	S0301G	.105 (2.65)	.035 (0.90)	.020 (0.50)	.075 (1.90)
02	.145 (3.68)	.105 (2.67)	.65 (16.5)	.325 (8.26)	.095 (2.42)	6.00 (152.4)	101-004-062-36	S0302G	.145 (3.68)	.055 (1.40)	.030 (0.72)	.105 (2.65)
03	.200 (5.08)	.170 (4.32)	.65 (16.5)	.325 (8.26)	.125 (3.18)	6.00 (152.4)	101-004-062-36	S0303G	.200 (5.08)	.085 (2.15)	.050 (1.25)	.170 (4.30)
04	.255 (6.48)	.235 (5.97)	.75 (19.0)	.325 (8.26)	.125 (3.18)	6.00 (152.4)	101-004-062-36	S0304G	.255 (6.45)	.130 (3.30)	.070 (1.80)	.235 (5.95)
05	.300 (7.62)	.275 (7.0)	.75 (19.0)	.325 (8.26)	.125 (3.18)	6.00 (152.4)	101-004-062-36	S0305G	.300 (7.60)	.170 (4.30)	.100 (2.50)	.275 (7.00)
06	.105 (2.67)	.075 (1.91)	.65 (16.5)	.325 (8.26)	.095 (2.42)	6.00 (152.4)	101-004-031-36	S0306G	.105 (2.65)	.035 (0.90)	.020 (0.50)	.075 (1.90)
07	.145 (3.68)	.105 (2.67)	.65 (16.5)	.325 (8.26)	.095 (2.42)	6.00 (152.4)	101-004-031-36	S0307G	.145 (3.68)	.055 (1.40)	.030 (0.72)	.105 (2.65)
08	.200 (5.08)	.170 (4.32)	.65 (16.5)	.325 (8.26)	.125 (3.18)	6.00 (152.4)	101-004-031-36	S0308G	.200 (5.08)	.085 (2.15)	.050 (1.25)	.170 (4.30)
09	.255 (6.48)	.235 (5.97)	.75 (19.0)	.325 (8.26)	.125 (3.18)	6.00 (152.4)	101-004-031-36	S0309G	.255 (6.45)	.130 (3.30)	.070 (1.80)	.235 (5.95)
10	.300 (7.62)	.275 (6.99)	.75 (19.0)	.325 (8.26)	.125 (3.18)	6.00 (152.4)	101-004-031-36	S0310G	.300 (7.60)	.170 (4.30)	.100 (2.50)	.275 (7.00)

TABLE II: Nickel Copper Braid per A-A-59569 Dimensions, Marking Code and Braid Information

Size	A Dia Min	B Dia Min	P ± .07 (1.8)	D Min	W Ref	L Min	NiCu Braid 36 AWG Ref 101-004	Marking Code	E Dia Max	F Dia Min	G Dia Min	H Dia Max
11	.105 (2.67)	.075 (1.91)	.65 (16.5)	.325 (8.26)	.095 (2.42)	6.00 (152.4)	101-004-062-36N	S0311G	.105 (2.65)	.035 (0.90)	.020 (0.50)	.075 (1.90)
12	.145 (3.68)	.105 (2.67)	.65 (16.5)	.325 (8.26)	.095 (2.42)	6.00 (152.4)	101-004-062-36N	S0312G	.145 (3.68)	.055 (1.40)	.030 (0.72)	.105 (2.65)
13	.200 (5.08)	.170 (4.32)	.65 (16.5)	.325 (8.26)	.125 (3.18)	6.00 (152.4)	101-004-062-36N	S0313G	.200 (5.08)	.085 (2.15)	.050 (1.25)	.170 (4.30)
14	.255 (6.48)	.235 (5.97)	.75 (19.0)	.325 (8.26)	.125 (3.18)	6.00 (152.4)	101-004-062-36N	S0314G	.255 (6.45)	.130 (3.30)	.070 (1.80)	.235 (5.95)
15	.300 (7.62)	.275 (7.0)	.75 (19.0)	.325 (8.26)	.125 (3.18)	6.00 (152.4)	101-004-062-36N	S0315G	.300 (7.60)	.170 (4.30)	.100 (2.50)	.275 (7.00)
16	.105 (2.67)	.075 (1.91)	.65 (16.5)	.325 (8.26)	.095 (2.42)	6.00 (152.4)	101-004-031-36N	S0316G	.105 (2.65)	.035 (0.90)	.020 (0.50)	.075 (1.90)
17	.145 (3.68)	.105 (2.67)	.65 (16.5)	.325 (8.26)	.095 (2.42)	6.00 (152.4)	101-004-031-36N	S0317G	.145 (3.68)	.055 (1.40)	.030 (0.72)	.105 (2.65)
18	.200 (5.08)	.170 (4.32)	.65 (16.5)	.325 (8.26)	.125 (3.18)	6.00 (152.4)	101-004-031-36N	S0318G	.200 (5.08)	.085 (2.15)	.050 (1.25)	.170 (4.30)
19	.255 (6.48)	.235 (5.97)	.75 (19.0)	.325 (8.26)	.125 (3.18)	6.00 (152.4)	101-004-031-36N	S0319G	.255 (6.45)	.130 (3.30)	.070 (1.80)	.235 (5.95)
20	.300 (7.62)	.275 (6.99)	.75 (19.0)	.325 (8.26)	.125 (3.18)	6.00 (152.4)	101-004-031-36N	S0320G	.300 (7.60)	.170 (4.30)	.100 (2.50)	.275 (7.00)

TABLE IV: ArmorLite™ Braid Dimensions, Marking Code and Braid Information

Size	A Dia Min	B Dia Min	P ± .07 (1.8)	D Min	W Ref	L Min	ArmorLite™ Braid	Marking Code	E Dia Max	F Dia Min	G Dia Min	H Dia Max
31	.105 (2.67)	.075 (1.91)	.65 (16.5)	.325 (8.26)	.095 (2.42)	6.00 (152.4)	103-027-004	S0331G	.105 (2.65)	.035 (0.90)	.020 (0.50)	.075 (1.90)
32	.145 (3.68)	.105 (2.67)	.65 (16.5)	.325 (8.26)	.095 (2.42)	6.00 (152.4)	103-027-004	S0332G	.145 (3.68)	.055 (1.40)	.030 (0.72)	.105 (2.65)
33	.200 (5.08)	.170 (4.32)	.65 (16.5)	.325 (8.26)	.125 (3.18)	6.00 (152.4)	103-027-004	S0333G	.200 (5.08)	.085 (2.15)	.050 (1.25)	.170 (4.30)
34	.255 (6.48)	.235 (5.97)	.75 (19.0)	.325 (8.26)	.125 (3.18)	6.00 (152.4)	103-027-004	S0334G	.255 (6.45)	.130 (3.30)	.070 (1.80)	.235 (5.95)
35	.300 (7.62)	.275 (7.0)	.75 (19.0)	.325 (8.26)	.125 (3.18)	6.00 (152.4)	103-027-004	S0335G	.300 (7.60)	.170 (4.30)	.100 (2.50)	.275 (7.00)
36	.105 (2.67)	.075 (1.91)	.65 (16.5)	.325 (8.26)	.095 (2.42)	6.00 (152.4)	103-027-002	S0336G	.105 (2.65)	.035 (0.90)	.020 (0.50)	.075 (1.90)
37	.145 (3.68)	.105 (2.67)	.65 (16.5)	.325 (8.26)	.095 (2.42)	6.00 (152.4)	103-027-002	S0337G	.145 (3.68)	.055 (1.40)	.030 (0.72)	.105 (2.65)
38	.200 (5.08)	.170 (4.32)	.65 (16.5)	.325 (8.26)	.125 (3.18)	6.00 (152.4)	103-027-002	S0338G	.200 (5.08)	.085 (2.15)	.050 (1.25)	.170 (4.30)
39	.255 (6.48)	.235 (5.97)	.75 (19.0)	.325 (8.26)	.125 (3.18)	6.00 (152.4)	103-027-002	S0339G	.255 (6.45)	.130 (3.30)	.070 (1.80)	.235 (5.95)
40	.300 (7.62)	.275 (6.99)	.75 (19.0)	.325 (8.26)	.125 (3.18)	6.00 (152.4)	103-027-002	S0340G	.300 (7.60)	.170 (4.30)	.100 (2.50)	.275 (7.00)

HIGH-PERFORMANCE

BRAIDED SHIELDING

EMI shielding · weight reduction · abrasion protection · grounding

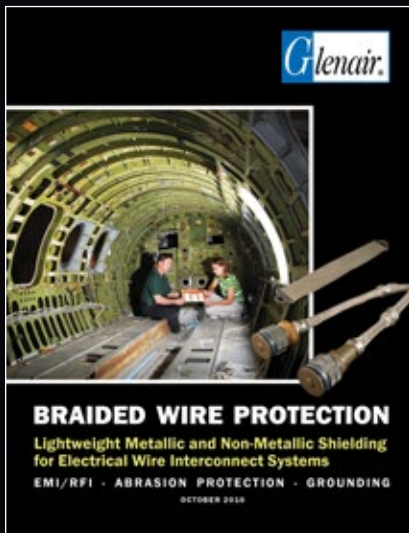

Glenair.

BRAIDED WIRE PROTECTION
Lightweight Metallic and Non-Metallic Shielding for Electrical Wire Interconnect Systems
EMI/RFI · ABRASION PROTECTION · GROUNDING
OCTOBER 2016



Glenair.

FLEXIBLE, LIGHTWEIGHT WRAPAROUND SHIELD BRAID

MasterWrap™
ARMORLITE™ SELF-WRAPPING WIRE PROTECTION SAVES TIME AND WEIGHT
SEPTEMBER 2013



Glenair.

LIGHTWEIGHT ARMORLITE™
Microfilament nickel-clad stainless steel EMI/RFI braided shielding

- Ultra-lightweight EMI/RFI braiding for high-temperature applications: 400°C to 2300°C
- Microfilament stainless steel: 70% lighter than NCU A.A. 99569/QB575
- Outstanding EMI/RFI shielding and conductivity
- Aerospace environment qualified
- Superior flexibility and "windowing" resistance: 90 to 95% optical coverage
- 220,000 psi (min) tensile strength
- Best performing metallic braid during lightning tests (per the ANSYS EA-364-75-1997 Waveform S8)

Save weight and money every time you fly. All-Up Weight (AUW) has met its match. ArmorLite™ microfilament stainless steel braid saves pounds compared to standard QQ-B-375/A.A. 99569 EMI/RFI shielding. ArmorLite™ is an expandable, flexible, high-strength, conductive stainless steel microfilament material designed for use as EMI/RFI shielding in high performance interconnect cabling. The principal benefit of ArmorLite™ is its extreme light weight compared to conventional Nickel/Copper shielding. By way of comparison, 100 feet of 5/8 inch ArmorLite™ is more than four pounds lighter than standard 175 A.A. 99569 shielding. The ArmorLite™ offers superior temperature tolerance compared to lightweight non-metallic braiding such as AmberStrand™.

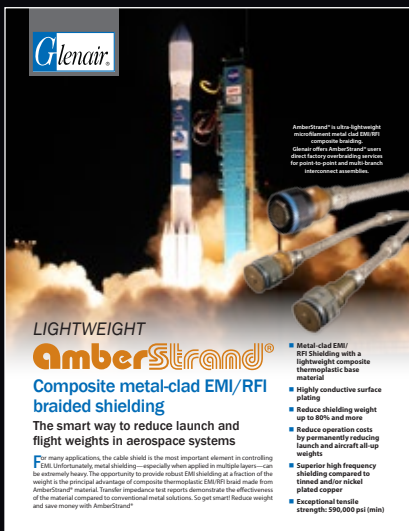

Glenair.

LIGHTWEIGHT AmberStrand™
Composite metal-clad EMI/RFI braided shielding
The smart way to reduce launch and flight weights in aerospace systems

- Metal-clad EMI/RFI shielding with a lightweight composite thermoplastic base material
- Highly conductive surface plating
- Reduce shielding weight up to 80% and more
- Reduce operation costs by permanently reducing launch and aircraft all-up weights
- Superior high frequency shielding compared to tin-plated and/or nickel-plated copper
- Exceptional tensile strength: 590,000 psi (min)

For many applications, the cable shield is the most important element in controlling EMI. Unfortunately metal shielding—especially when applied in multiple layers—can be extremely heavy. The opportunity to provide robust EMI shielding at a fraction of the weight is the principal advantage of composite thermoplastic EMI/RFI braid made from AmberStrand™ material. Tensile impedance test reports demonstrate the effectiveness of the material compared to conventional metal solutions. So get smart. Reduce weight and save money with AmberStrand™.

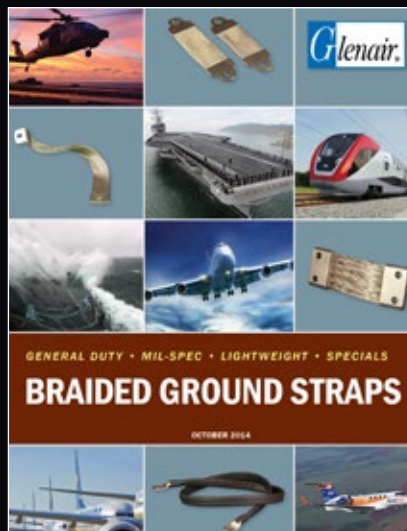

Glenair.

GENERAL DUTY · MIL-SPEC · LIGHTWEIGHT · SPECIALS

BRAIDED GROUND STRAPS
OCTOBER 2014



ARMORLITE™ MESH TAPE

For spot EMI/RFI shielding coverage and reinforcement of cable interstices. MasterWrap™ with Nomex® available for mechanical / abrasion spot coverage and repair.

ARMORLITE™ AmberStrand®

LIGHTWEIGHT ARMORLITE™ (STAINLESS STEEL) AND AMBERSTRAND® (COMPOSITE) SHIELDING



Tubular AmberStrand® and ArmorLite™ lightweight metal-clad microfilament EMI/RFI braided shielding



Shield sock backshells with lightweight ArmorLite™ or AmberStrand® microfilament EMI/RFI braid



MasterWrap™ flexible, field-installable/repairable side-entry EMI/RFI shielding with ArmorLite™ technology. MasterWrap™ with Nomex® available for abrasion/thermal protection.

TURNKEY FACTORY OVERBRAIDING WITH LIGHTWEIGHT AND QQ-B-575B/A-A-59569 BRAID



Turnkey factory-overbraided multibranch cable assembly



Overbraided conduit assembly, ready for customer termination



Factory-overbraided pigtail assembly

ARMORLITE™ AND METALLIC BRAID GROUND STRAPS

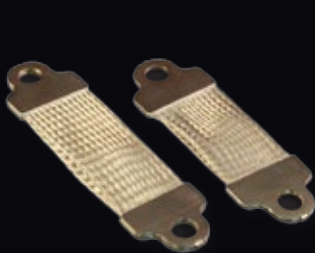

Lightweight ArmorLite™ microfilament ground straps



Heavy-duty metallic braid ground straps



MIL-DTL-24749 Type IV Qualified navy ground straps



Round braid profile ground straps

INDUSTRY-STANDARD TUBULAR FABRIC AND METAL BRAID

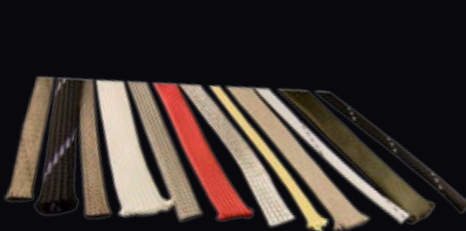

Tubular fabric braid for mechanical and abrasion protection of electrical wire interconnect systems



Wide range of colored Nomex® for abrasion protection and wire identification

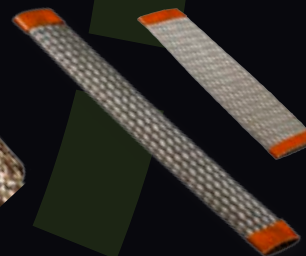

QQ-B-575B/A-A-59569 metallic braid for EMI shielding



High-temperature fiberglass braid for engine applications

Glenair Braiding and Weaving

WIRE PROTECTION AND SHIELDING

Complete vertical integration—the most capable braiding and weaving facility in the interconnect industry

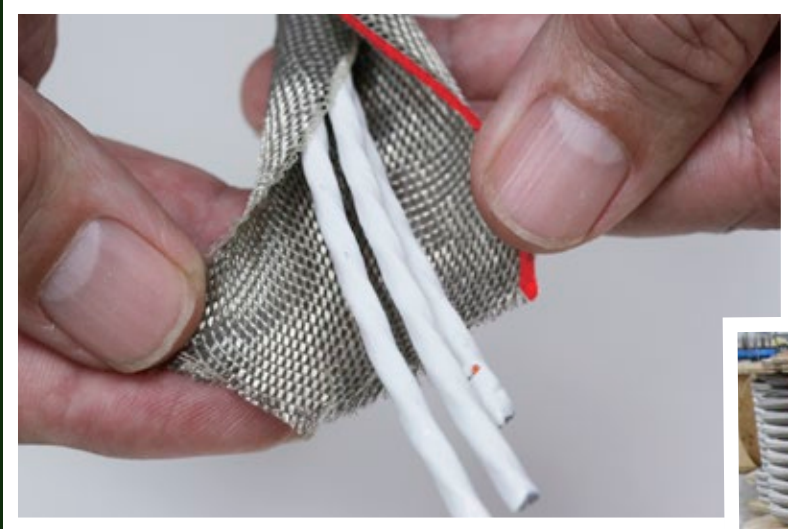

Glenair operates the largest braiding and weaving operation in the interconnect industry, including over 50 Wardwell Rapid Braiders, looms, termination welders, as well as comprehensive electrical and mechanical testing equipment.



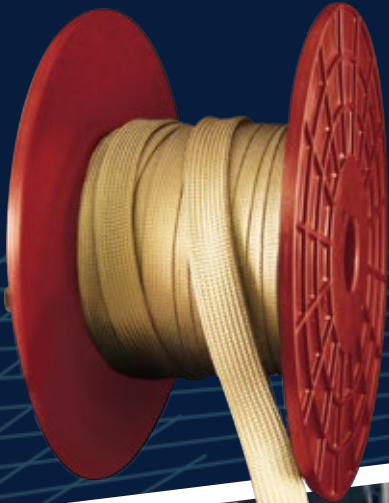

Glenair's braiding and weaving capability includes the fabrication of bulk tubular sleeves and wraps, as well as direct overbraiding services for complex cable and conduit wire harness assemblies

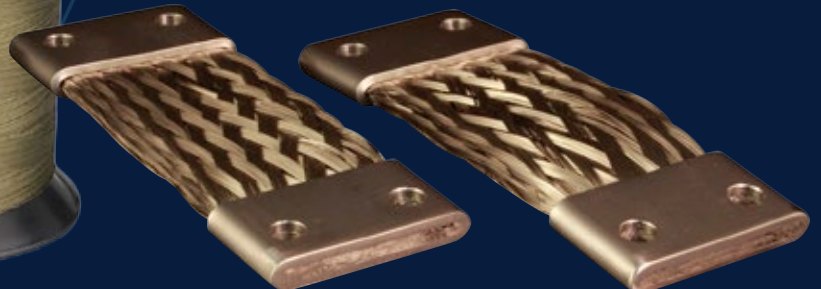
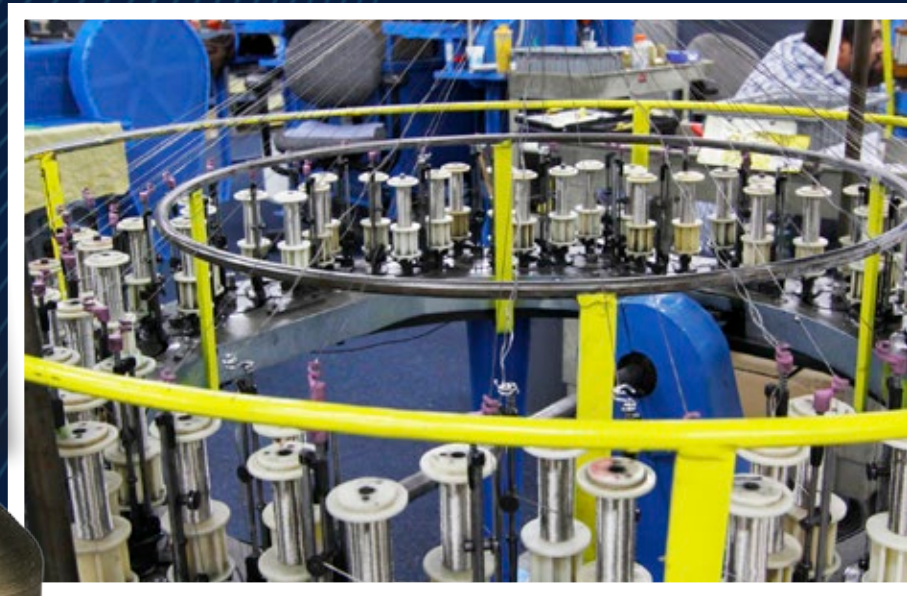



Out of This World
**INTERCONNECT
SOLUTIONS**

Glenair, Inc.

1211 Air Way • Glendale, California • 91201-2497

Telephone: 818-247-6000 • Fax: 818-500-9912 • sales@glenair.com

www.glenair.com

**Glenair Power
Products Group** Telephone: 203-741-1115
860 N. Main Street Extension Facsimile:
Wallingford, CT 203-741-0053
06492 sales@glenair.com

Glenair UK Ltd Telephone: +44-1623-638100
40 Lower Oakham Way Facsimile:
Oakham Business Park +44-1623-638111
P.O. Box 37, Mansfield sales@glenair.co.uk
Notts, NG18 5BY England

Glenair Microway Systems Telephone: 847-679-8833
7000 North Lawndale Avenue Facsimile:
Lincolnwood, IL 847-679-8849
60712

Glenair Nordic AB Telephone: +46-8-50550000
Gustav III : S Boulevard 46 sales@glenair.se
SE-169 27 Solna
Sweden

Glenair Electric GmbH Telephone: 06172 / 68 16 0
Schaberweg 28 Facsimile:
61348 Bad Homburg 06172 / 68 16 90
Germany info@glenair.de

Glenair Iberica Telephone: +34-925-89-29-88
C/ La Vega, 16 Facsimile:
45612 Velada +34-925-89-29-87
Spain sales@glenair.es

Glenair Italia S.p.A. Telephone: +39-051-782811
Via Del Lavoro, 7 Facsimile:
40057 Quarto Inferiore – +39-051-782259
Granarolo dell'Emilia info@glenair.it
Bologna, Italy

Glenair France SARL Telephone: +33-5-34-40-97-40
7, Avenue Parmentier Facsimile:
Immeuble Central Parc #2 +33-5-61-47-86-10
31200 Toulouse sales@glenair.fr
France

Glenair Korea Telephone: +82-31-8068-1090
B-1304 Gunpo IT Valley Facsimile:
148 Gosan-Ro, Gunpo-Si +82-31-8068-1092
Kyunggi-Do, Korea sales@glenair.kr
435-733

