

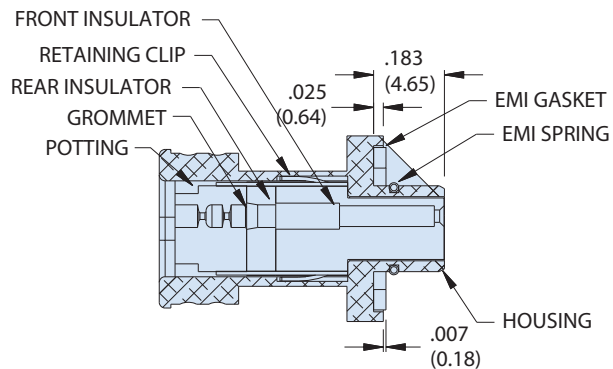



790-065 Rear Panel Mount, Straight Wire / Cable Version Connector, Plug, Socket Contacts with Crimp Removable Contacts



NOTES

- Refer to drawing 799-009 for insert arrangements details.
- Refer to drawing 799-008 for complete materials, finishes, and performance specifications.
- Refer to catalog for application tooling information.
- Refer to drawing 799-005 for panel cutouts.
- Ground spring is available only with nickel, teflon nickel, gold or chem film plating on the shell.
- Blind Mate
 - Shell sizes A, B, C, D, E, F, G, J, K
 - ±.030 (0.76) allowable misalignment from centerline
- Shell sizes H, L
 - ±.040 (1.02) allowable misalignment from centerline

HOW TO ORDER	
Sample Part Number	790-065 -S H-66 M E G
Basic Part Number	790-065 Rear Panel Mount, Straight Wire / Cable Version Connector, Plug, Socket Contacts with Crimp Removable Contacts
Contact Type	S = Socket Contacts
Insert Arrangement	See Insert Arrangements table
Shell Finish	M = Electroless Nickel Z2 = Gold MT = Teflon Nickel E = Chemfilm N = Cadmium with Olive Drab Chromate J = Cadmium with Yellow Chromate UC = Zinc Colbalt with Black Chromate
EMI Spring	E = EMI Spring N = No EMI Spring
Mating Hardware Option	P = Jackpost S = Female Guide Sockets G = Male Guide Pins N = No Mating Hardware

Mounting Hardware	
P Jackpost 	Connector supplied with non-removable jackpost. Shell sizes "H" and "L" have 4-40 UNC-2B thread. All other sizes have 2-56 UNC-2B thread.
G Guide Pin 	Connector supplied with non-removable guide pins for blind mate applications. Mates with option "S" guide socket on corresponding receptacle connector.
S Guide Socket 	Connector supplied with non-removable hardware guide sockets for blind mate applications. Mates with option "G" guide pin on corresponding receptacle connector.

Dimensions in Inches (millimeters) are subject to change without notice.





790-065 Rear Panel Mount, Straight Wire / Cable Version Connector, Plug, Socket Contacts with Crimp Removable Contacts

Dimensions

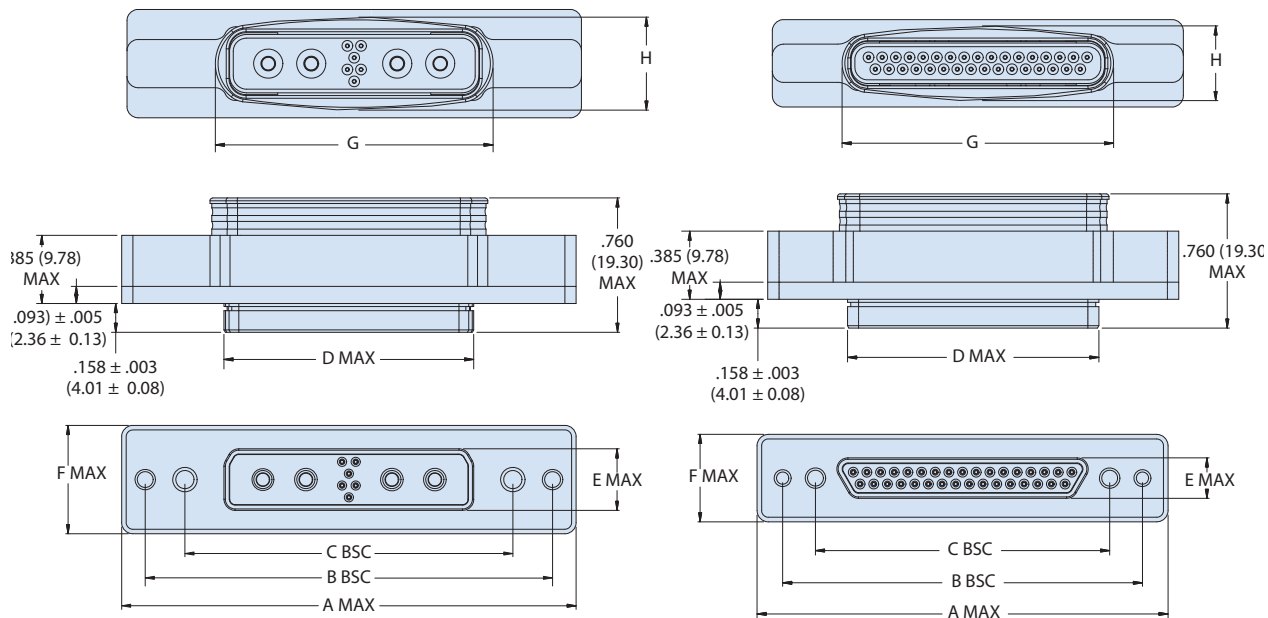

SHELL SIZES H & L
H-10P4 SHOWN

SHELL SIZES A THRU G, J, & K
J-33 SHOWN
(NOTE THAT SIZE G HAS 3 CONTACT ROWS)

Size	A Max	B Bsc	C Bsc	D Max	E Max	F Max	G	H
A	1.211 (30.76)	0.925 (23.50)	0.565 (14.35)	.335 (8.51)	.233 (5.92)	0.485 (12.32)	0.440 (11.18)	0.360 (9.14)
B	1.361 (34.57)	1.075 (27.30)	0.715 (18.16)	.485 (12.32)	.233 (5.92)	0.485 (12.32)	0.590 (14.99)	0.370 (9.40)
C	1.511 (38.38)	1.225 (31.12)	0.865 (21.97)	.635 (16.13)	.233 (5.92)	0.485 (12.32)	0.740 (18.80)	0.390 (9.91)
D	1.611 (40.92)	1.325 (33.65)	0.965 (24.51)	.735 (18.67)	.233 (5.92)	0.485 (12.32)	0.840 (21.34)	0.400 (10.16)
E	1.761 (44.73)	1.475 (37.47)	1.115 (28.32)	.885 (22.48)	.233 (5.92)	0.485 (12.32)	0.990 (25.15)	0.400 (10.16)
F	1.911 (48.54)	1.625 (41.28)	1.265 (32.13)	1.035 (26.29)	.233 (5.92)	0.575 (14.60)	1.140 (28.96)	0.410 (10.41)
G	1.861 (47.27)	1.575 (40.00)	1.215 (30.86)	1.010 (25.65)	.320 (8.13)	0.395 (10.03)	1.130 (28.70)	0.490 (12.45)
H	2.500 (63.50)	2.236 (56.79)	1.800 (45.72)	1.385 (35.18)	.349 (8.86)	0.600 (15.24)	1.525 (38.73)	0.510 (12.95)
J	2.261 (57.43)	1.975 (50.17)	1.615 (41.02)	1.390 (35.31)	.233 (5.92)	0.485 (12.32)	1.490 (37.85)	0.410 (10.41)
K	2.661 (67.59)	2.375 (60.33)	2.015 (51.18)	1.795 (45.59)	.233 (5.92)	0.485 (12.32)	1.890 (48.01)	0.430 (10.92)
L	2.736 (69.49)	2.472 (62.79)	2.036 (51.71)	1.623 (41.22)	.349 (8.86)	0.600 (15.24)	1.760 (44.70)	0.520 (13.21)

Dimensions in Inches (millimeters) are subject to change without notice.

790-065 Rear Panel Mount, Straight Wire / Cable Version Connector, Plug, Socket Contacts with Crimp Removable Contacts



Insert Arrangements

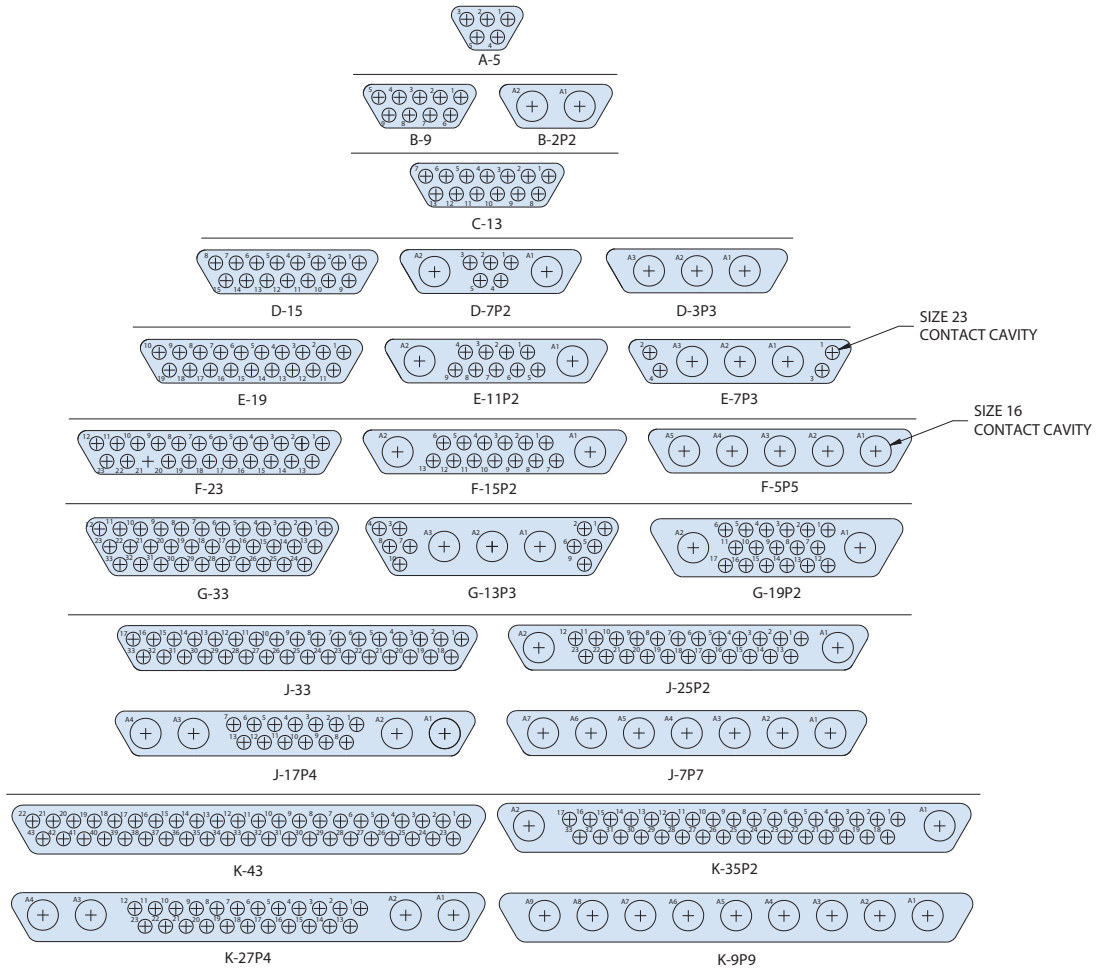

Dimensions in Inches (millimeters) are subject to change without notice.



790-065
Rear Panel Mount, Straight Wire / Cable Version
Connector, Plug, Socket Contacts
with Crimp Removable Contacts

Socket Insert Arrangements

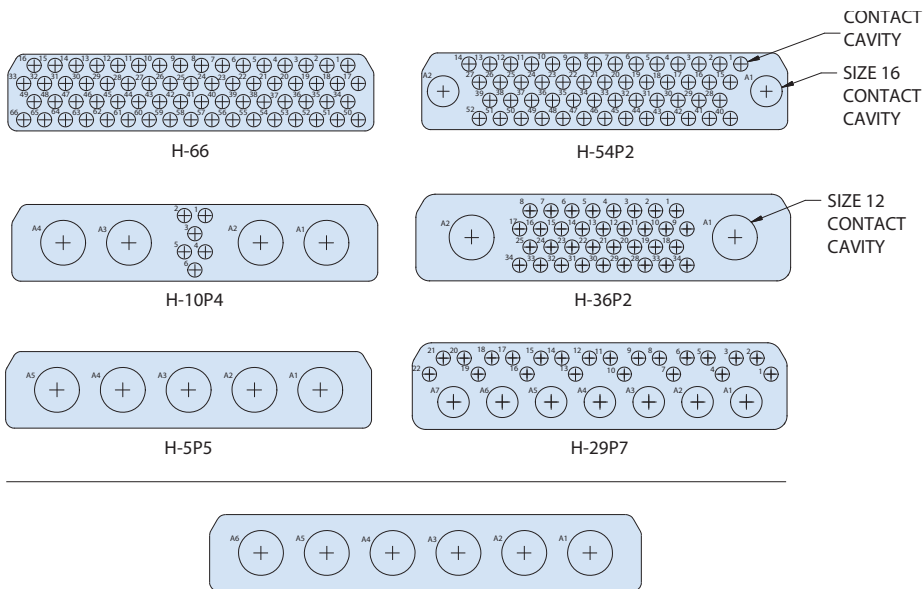

Dimensions in Inches (millimeters) are subject to change without notice.