

233-103-H9 Jam Nut Mount Hermetic Plug/Receptacle Bulkhead Feed-Thru for MIL-DTL-38999 Series III Type



Bulkhead
Feed-Thru

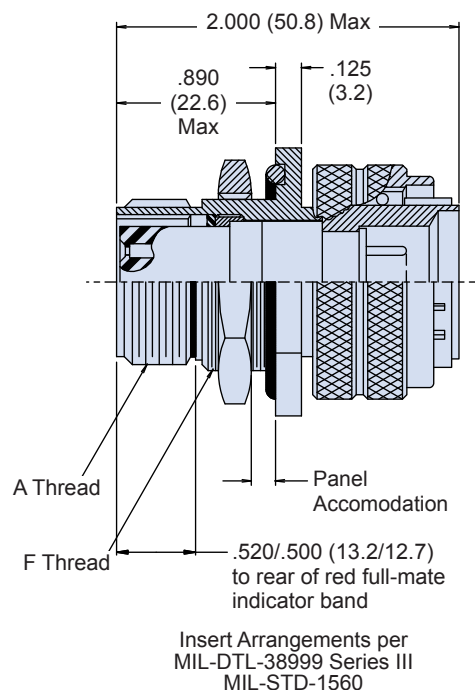
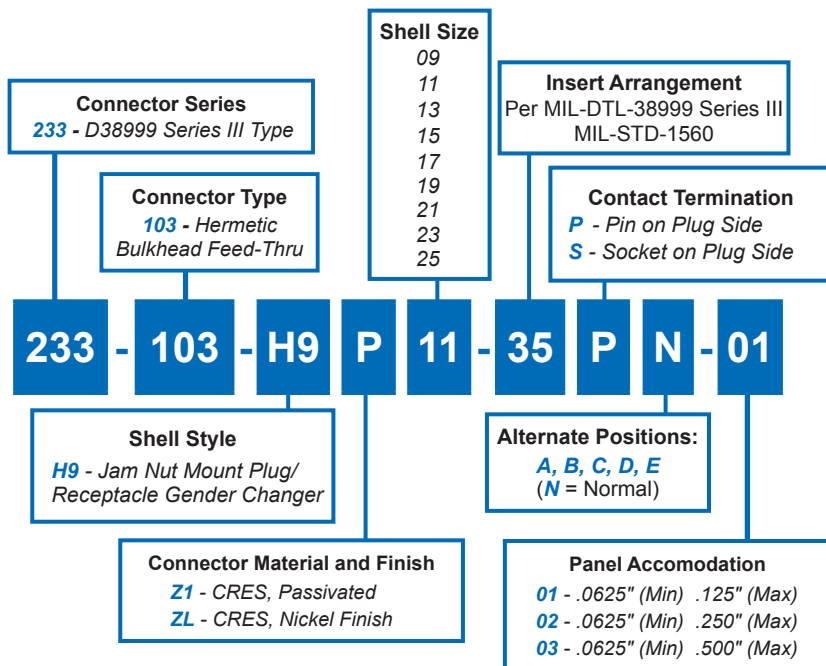
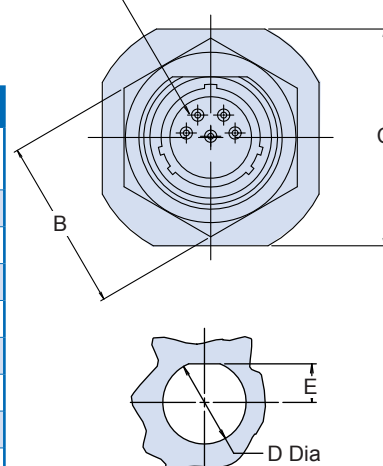

TABLE I: CONNECTOR DIMENSIONS

SHELL SIZE	A THREAD 0.1 P-0.3L-TS-2	B DIM	C DIM MAX	D DIA	E DIM	F THREAD x1-6g-0.100R
9	.6250	.945(24.0)	1.090(27.7)	.698(17.7)	.322(8.9)	M17
11	.7500	1.063(27.0)	1.280(32.5)	.822(20.9)	.385(9.8)	M20
13	.8750	1.260(32.0)	1.400(35.6)	1.010(27.6)	.479(12.3)	M25
15	1.0000	1.417(36.0)	1.530(38.9)	1.135(28.8)	.541(13.7)	M28
17	1.1875	1.457(37.0)	1.660(42.2)	1.260(32.0)	.604(15.3)	M32
19	1.2500	1.614(41.0)	1.840(46.7)	1.385(35.2)	.635(16.1)	M35
21	1.3750	1.811(46.0)	1.970(50.5)	1.510(38.4)	.698(17.7)	M38
23	1.5000	1.968(50.0)	2.090(53.1)	1.635(41.5)	.760(19.3)	M41
25	1.6250	2.017(51.2)	2.210(56.1)	1.760(44.7)	.822(20.9)	M44



Recommended
Panel Cut-Out

APPLICATION NOTES

- Power to a given contact on one end will result in power to contact directly opposite, regardless of identification letter.
- Hermeticity = less than 1×10^{-7} cc/sec at one atmosphere. Not for use in liquid atmosphere.
- Material/finish:
Shell, nut – CRES/passivated, carbon steel/fused tin or CRES/nickel per QQ-N-290.
- Contacts – Gold Plated. Pin: alloy 52; Skt.: copper alloy
Insulator – fused vitreous glass/N.A.
Seals – fluorosilicone rubber/N.A.