

SERIES 89 NANOMINIATURE Dual-Row Rectangular Connectors



891-012 and 891-013 Right-Angle Surface Mount PCB Connector

DUAL-ROW RECTANGULAR CONNECTORS



Right-Angle Surface Mount Connectors feature gold alloy TwistPin contacts. These nanominiature connectors offer premium performance and reliability for demanding applications.
Pre-Tinned PC Tails are coated with Sn63Pb37 or Sn60Pb40 tin-lead for excellent solderability.

Choose Aluminum, Titanium or Stainless Steel Shells in eleven layouts from 9 to 85 contacts. Complies to the requirements of MIL-DTL-32139.

HOW TO ORDER						
Sample Part Number		891-012	-25P	A2	-BRS	T
Series	891-012 = Plug, Right-Angle Surface Mount Connector 891-013 = Receptacle, Right-Angle Surface Mount Connector					
Insert Arrangement/Contact Type	Pins (891-012 Plugs) 9P, 15P, 21P, 25P, 31P, 37P, 41P, 51P, 65P, 69P, 85P, 91P Socket (891-013 Receptacles) 9S, 15S, 21S, 25S, 31S, 37S, 41S, 51S, 65S, 69S, 85S, 91S					
Shell Material and Finish	A1 = Aluminum Shell, Cadmium Plating A2 = Aluminum Shell, Electroless Nickel Plating A31 = Aluminum Shell, Zinc Nickel Plating, Black A33 = Aluminum Shell, Nickel PTFE Plating T = Titanium Shell, Unplated S = Stainless Steel Shell, Passivated					
Termination Type	BRS = Board Right-Angle Surface Mount					
Hardware	T = Female Thread (Stainless Steel Inserts installed in Aluminum Shells, tapped directly into stainless steel and titanium shells)					

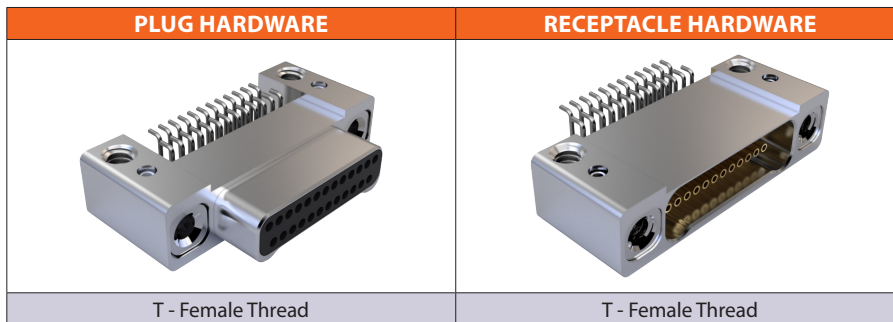

PERFORMANCE SPECIFICATIONS
Contact Spacing: .025" (0.64) contact centers
Current Rating: 1 AMP maximum tested per EIA-364-70
DWV: 250 VAC RMS sea level, 100 VAC RMS 70,000 feet per EIA-364 Procedure 20
Insulation Resistance: 5000 Megohms minimum test voltage 100 VDC, per EIA-364 Procedure 21
Operating Temperature: -55° C. to +125° C.
Contact Resistance: 71 millivolt drop maximum, 1 AMP current, any catalog supported wire type
Vibration: 20 g's, IAW EIA-364-28, Condition IV
Shock: 100 g's, IAW EIA-364-27, Condition G
Durability: 200 mating cycles per test procedure EIA-364-09
Corrosion Resistance: 48 hours salt spray IAW EIA-364-26, Condition B
Humidity: 240 hours, IAW EIA-364-31, Test Condition B
Contact Engaging/Separation Force: 5 ounce maximum, 0.4 ounce minimum
Thermal Vacuum Outgassing: Total mass loss (TML) 1.0% max., volatile condensable material (VCM) 0.1% max. IAW ASTM E595

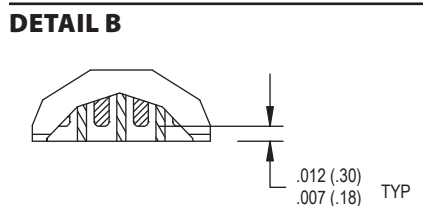
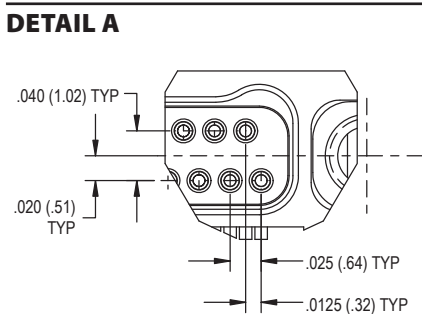

NOTES

- Material and Finish:
 - Shell: see part number break down
 - Insulator: LCP/N/A
 - Contacts: gold alloy / unplated
 - Pre-tinned PC tails: coated with Sn63Pb37 or Sn60Pb40 tin-lead
 - Hardware: passivated stainless steel
- Inspect and test IAW MIL-DTL-32139
- Interface dimensions per MIL-DTL-32139/3 and /4

SERIES 89 NANOMINIATURE Dual-Row Rectangular Connectors



891-012 and 891-013 Right-Angle Surface Mount PCB Connector

DIMENSIONS

891-012 Plug (Pin) Connectors

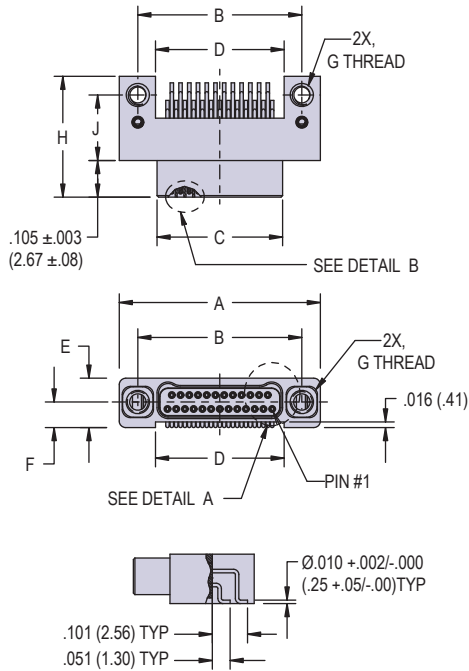

891-013 Receptacle (Socket) Connectors

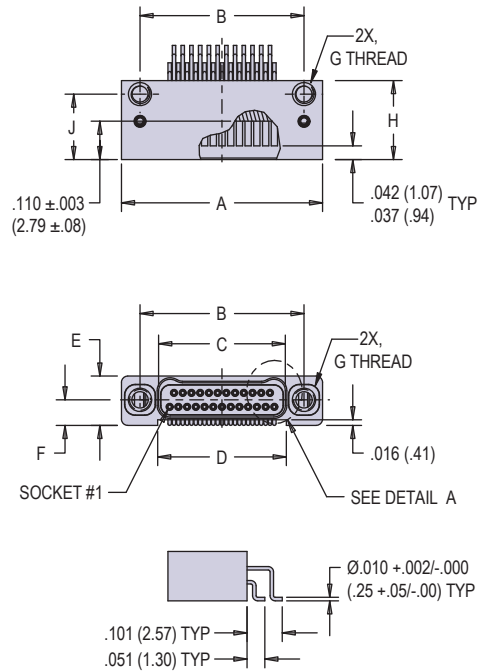

Layout	A	B BSC.	C BSC.	D	E	F BSC.	G Thread	H	J
9P	.375 (9.53)	.270 (6.86)	.160 (4.06)	.170 (4.32)	.140 (3.56)	.0725 (1.84)	#0-80 UNF	.345 (8.76)	.187 (4.75)
9S	.375 (9.53)	.270 (6.86)	.163 (4.14)	.170 (4.32)	.140 (3.56)	.0725 (1.84)	#0-80 UNF	.225 (5.72)	.187 (4.75)
15P	.450 (11.43)	.345 (8.76)	.235 (5.97)	.245 (6.22)	.140 (3.56)	.0725 (1.84)	#0-80 UNF	.345 (8.76)	.187 (4.75)
15S	.450 (11.43)	.345 (8.76)	.238 (6.05)	.245 (6.22)	.140 (3.56)	.0725 (1.84)	#0-80 UNF	.225 (5.72)	.187 (4.75)
21P	.525 (13.34)	.420 (10.67)	.310 (7.87)	.320 (8.13)	.140 (3.56)	.0725 (1.84)	#0-80 UNF	.345 (8.76)	.187 (4.75)
21S	.525 (13.34)	.420 (10.67)	.313 (7.95)	.320 (8.13)	.140 (3.56)	.0725 (1.84)	#0-80 UNF	.225 (5.72)	.187 (4.75)
25P	.575 (14.61)	.470 (11.94)	.360 (9.14)	.370 (9.40)	.140 (3.56)	.0725 (1.84)	#0-80 UNF	.345 (8.76)	.187 (4.75)
25S	.575 (14.61)	.470 (11.94)	.363 (9.22)	.370 (9.40)	.140 (3.56)	.0725 (1.84)	#0-80 UNF	.225 (5.72)	.187 (4.75)
31P	.650 (16.51)	.545 (13.84)	.435 (11.05)	.445 (11.30)	.140 (3.56)	.0725 (1.84)	#0-80 UNF	.345 (8.76)	.187 (4.75)
31S	.650 (16.51)	.545 (13.84)	.438 (11.13)	.445 (11.30)	.140 (3.56)	.0725 (1.84)	#0-80 UNF	.225 (5.72)	.187 (4.75)
37P	.725 (18.42)	.620 (15.75)	.510 (12.95)	.520 (13.21)	.140 (3.56)	.0725 (1.84)	#0-80 UNF	.345 (8.76)	.187 (4.75)
37S	.725 (18.42)	.620 (15.75)	.513 (13.03)	.520 (13.21)	.140 (3.56)	.0725 (1.84)	#0-80 UNF	.225 (5.72)	.187 (4.75)
41P	.775 (19.69)	.670 (17.02)	.560 (14.22)	.570 (14.48)	.140 (3.56)	.0725 (1.84)	#0-80 UNF	.345 (8.76)	.187 (4.75)
41S	.775 (19.69)	.670 (17.02)	.563 (14.30)	.570 (14.48)	.140 (3.56)	.0725 (1.84)	#0-80 UNF	.225 (5.72)	.187 (4.75)
51P	.900 (22.86)	.795 (20.19)	.685 (17.40)	.695 (17.65)	.140 (3.56)	.0725 (1.84)	#0-80 UNF	.345 (8.76)	.187 (4.75)
51S	.900 (22.86)	.795 (20.19)	.688 (17.48)	.695 (17.65)	.140 (3.56)	.0725 (1.84)	#0-80 UNF	.225 (5.72)	.187 (4.75)
65P	1.075 (27.31)	.970 (24.64)	.860 (21.84)	.870 (22.10)	.140 (3.56)	.0725 (1.84)	#0-80 UNF	.345 (8.76)	.187 (4.75)
65S	1.075 (27.31)	.970 (24.64)	.863 (21.92)	.870 (22.10)	.140 (3.56)	.0725 (1.84)	#0-80 UNF	.225 (5.72)	.187 (4.75)
69P	1.125 (28.58)	1.020 (25.91)	.910 (23.11)	.920 (23.37)	.140 (3.56)	.0725 (1.84)	#0-80 UNF	.345 (8.76)	.187 (4.75)
69S	1.125 (28.58)	1.020 (25.91)	.913 (23.19)	.920 (23.37)	.140 (3.56)	.0725 (1.84)	#0-80 UNF	.225 (5.72)	.187 (4.75)
85P	1.377 (34.98)	1.246 (31.65)	1.110 (28.19)	1.120 (28.45)	.165 (4.19)	.085 (2.16)	#2-56 UNC	.375 (9.53)	.205 (5.21)
85S	1.377 (34.98)	1.246 (31.65)	1.113 (28.27)	1.120 (28.45)	.165 (4.19)	.085 (2.16)	#2-56 UNC	.270 (6.86)	.210 (5.33)
91P	1.452 (36.88)	1.321 (33.55)	1.185 (30.10)	1.195 (30.35)	.165 (4.19)	.0850 (2.16)	#2-56 UNC	.375 (9.53)	.205 (5.21)
91S	1.452 (36.88)	1.321 (33.55)	1.188 (30.18)	1.195 (30.35)	.365 (9.27)	.0850 (2.16)	#2-56 UNC	.270 (6.86)	.210 (5.33)

DUAL-ROW RECTANGULAR CONNECTORS

SERIES 89 NANOMINIATURE Dual-Row Rectangular Connectors



891-012 Right-Angle Surface Mount PCB Connectors - Plug Pad Footprint

DUAL-ROW RECTANGULAR CONNECTORS

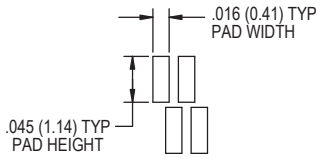

PAD FOOTPRINT DETAIL

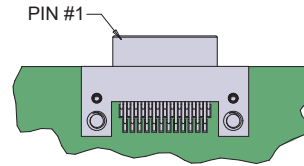

PIN #1 POSITION

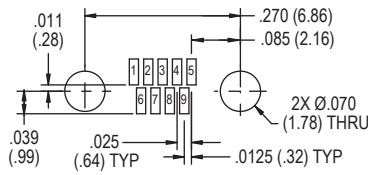

9 Contacts

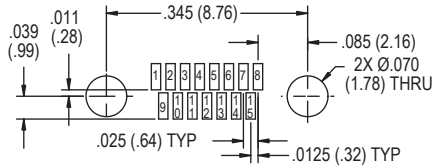

15 Contacts

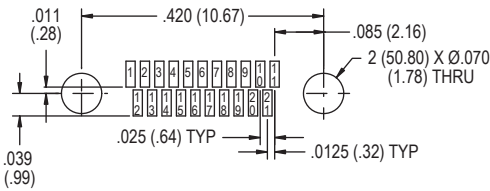

21 Contacts

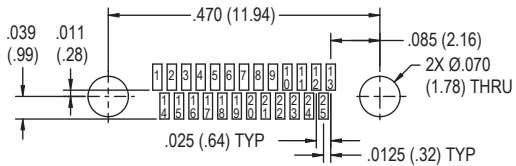

25 Contacts

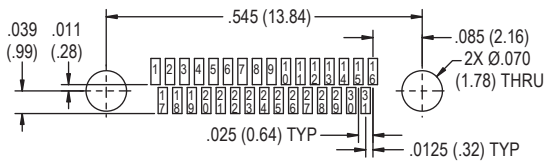

31 Contacts

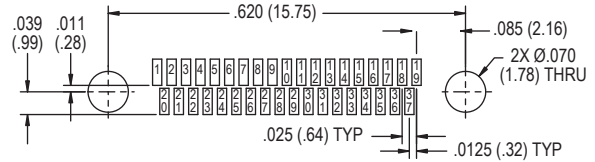

37 Contacts

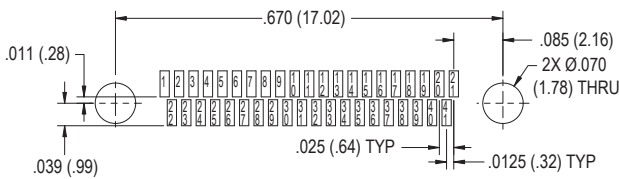

41 Contacts

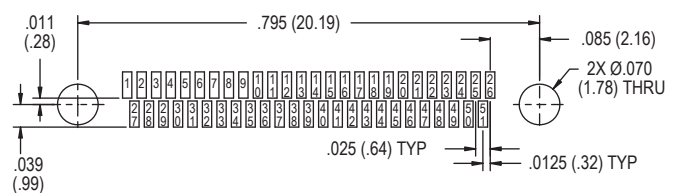

51 Contacts

Layouts shown are for connector mounting side of PC Board.

SERIES 89 NANOMINIATURE Dual-Row Rectangular Connectors



891-012 Right-Angle Surface Mount PCB Connectors - Plug Pad Footprint

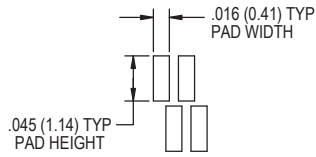

PAD FOOTPRINT DETAIL

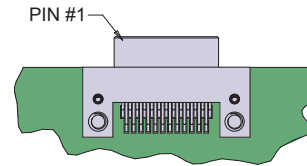

PIN #1 POSITION

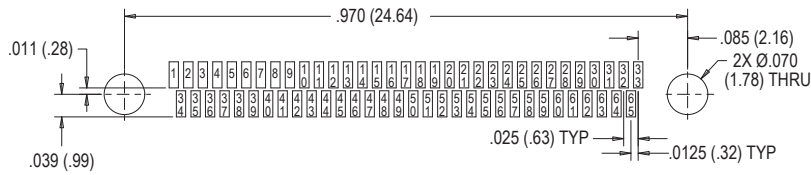

65 Contacts

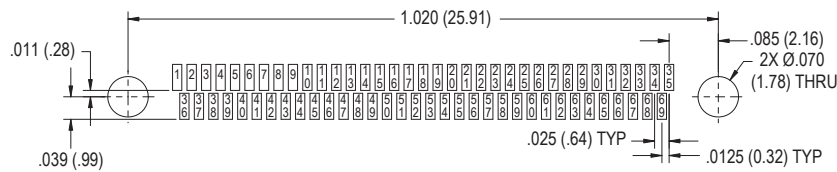

69 Contacts

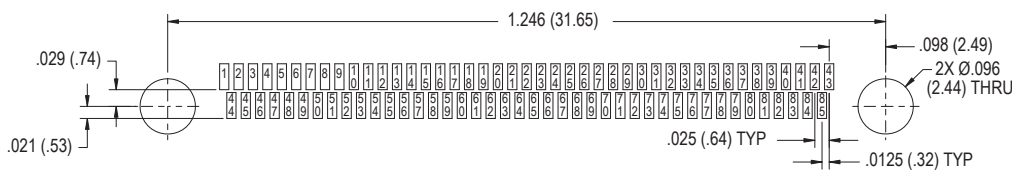

85 Contacts

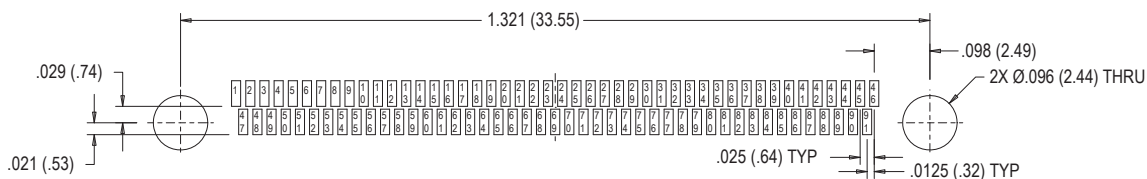

91 Contacts

Layouts shown are for connector mounting side of PC Board.

SERIES 89 NANOMINIATURE Dual-Row Rectangular Connectors



891-013 Right-Angle Surface Mount PCB Connectors - Receptacle Pad Footprint

DUAL-ROW RECTANGULAR CONNECTORS

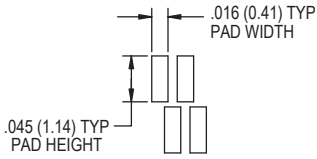

PAD FOOTPRINT DETAIL

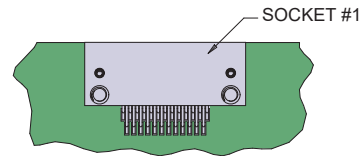

CONNECTOR ORIENTATION

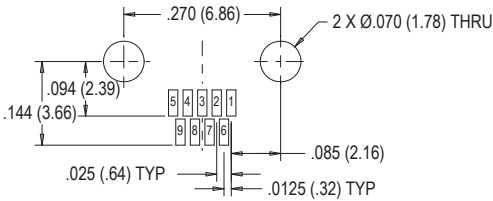

9 Contacts

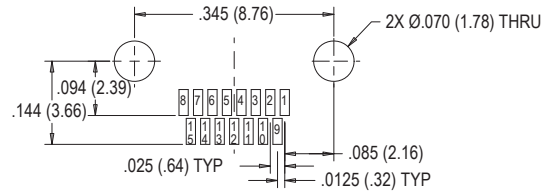

15 Contacts

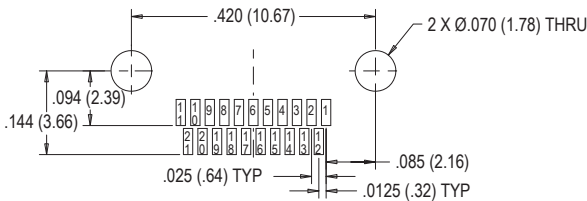

21 Contacts

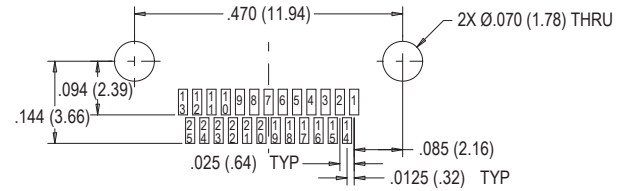

25 Contacts

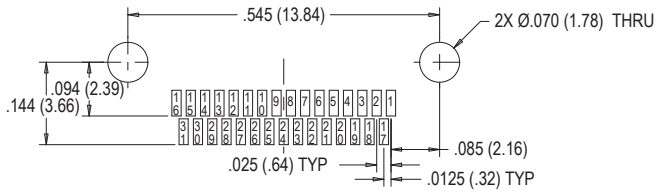

31 Contacts

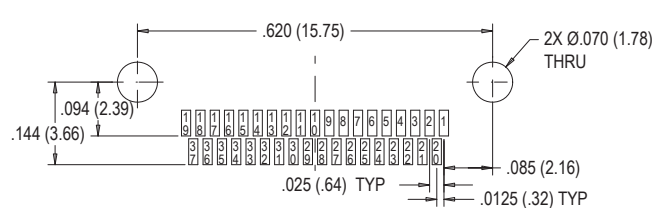

37 Contacts

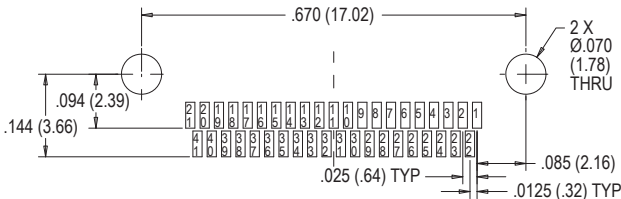

41 Contacts

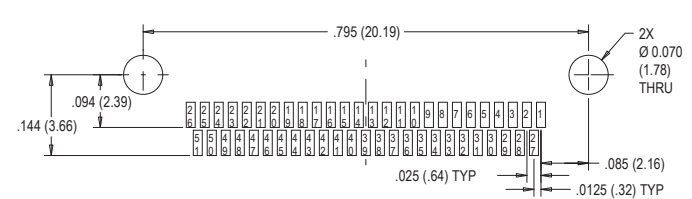

51 Contacts

Layouts shown are for connector mounting side of PC Board.

SERIES 89 NANOMINIATURE Dual-Row Rectangular Connectors



891-013 Right-Angle Surface Mount PCB Connectors - Receptacle Pad Footprint

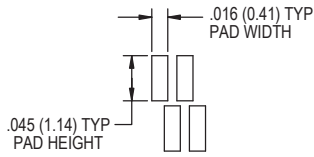

PAD FOOTPRINT DETAIL

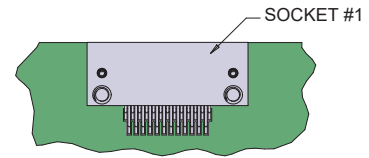

CONNECTOR ORIENTATION

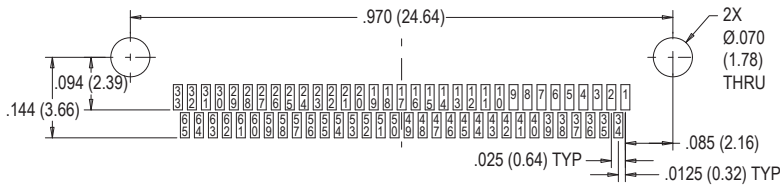

65 Contacts

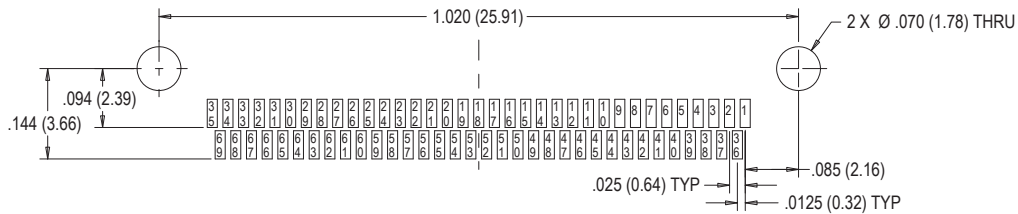

69 Contacts

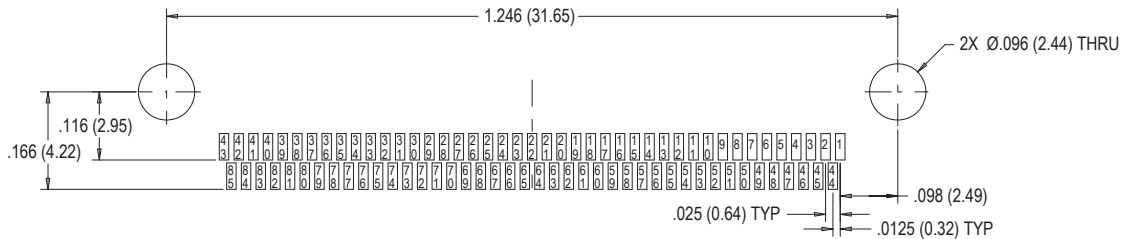

85 Contacts

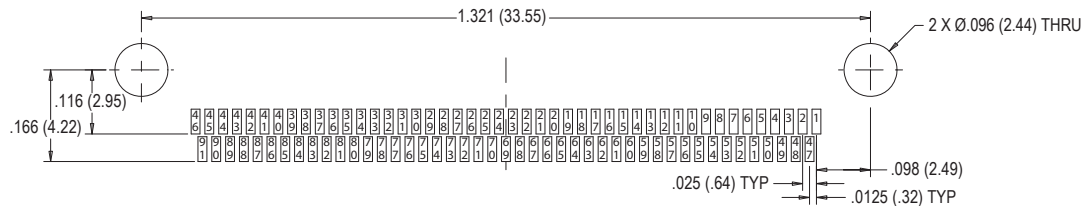

91 Contacts

Layouts shown are for connector mounting side of PC Board.