

# SERIES 89 NANOMINIATURE Dual-Row Rectangular Connectors

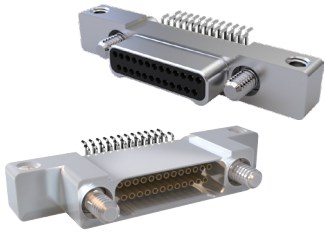

## 891-019 and 891-020 Right-Angle Surface Mount PCB Connector with Jackscrews

DUAL-ROW RECTANGULAR CONNECTORS



**Right-Angle Surface Mount PCB Nano Connectors** feature gold alloy TwistPin contacts. These nanominiature connectors offer premium performance and reliability for demanding applications. **Pre-Tinned PC Tails** are coated with Sn63Pb37 or Sn60Pb40 tin-lead for excellent solderability.

**Choose Aluminum, Titanium or Stainless Steel Shells** in twelve layouts from 9 to 91 contacts. Complies to the requirements of MIL-DTL-32139.

HOW TO ORDER						
<b>Sample Part Number</b>		<b>891-019</b>	<b>-25P</b>	<b>A2</b>	<b>-BRS</b>	<b>J</b>
<b>Series</b>	<b>891-019</b> = Plug, Right-Angle Surface Mount Connector with Jackscrews <b>891-020</b> = Receptacle, Right-Angle Surface Mount Connector with Jackscrews					
<b>Insert Arrangement/Contact Type</b>	Pins (891-019 Plugs): <b>9P, 15P, 21P, 25P, 31P, 37P, 41P, 51P, 65P, 69P, 85P</b> Sockets (891-020 Receptacles): <b>9S, 15S, 21S, 25S, 31S, 37S, 41S, 51S, 65S, 69S, 85S</b>					
<b>Shell Material and Finish</b>	<b>A1</b> = Aluminum Shell, Cadmium Plating <b>A2</b> = Aluminum Shell, Electroless Nickel Plating <b>A31</b> = Aluminum Shell, Zinc Nickel Plating, Black <b>A33</b> = Aluminum Shell, Nickel PTFE Plating <b>T</b> = Titanium Shell, Unplated <b>S</b> = Stainless Steel Shell, Passivated					
<b>Termination Type</b>	<b>BRS</b> = Board Right-Angle Surface Mount					
<b>Hardware</b>	<b>J</b> = Hex Head Jackscrew					

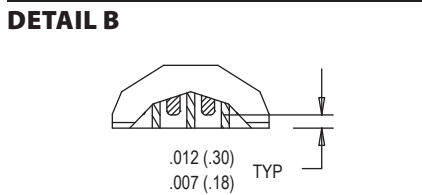
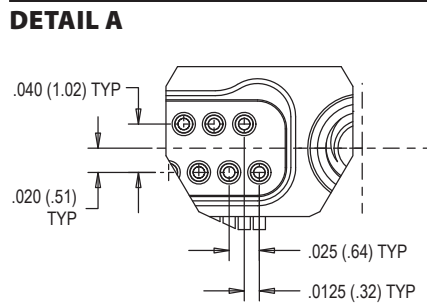
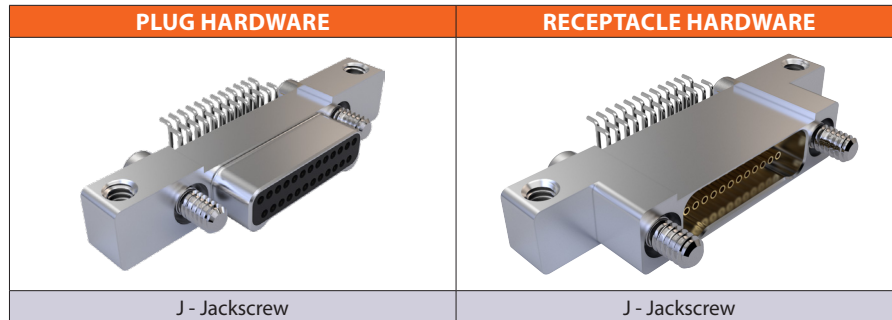

### NOTES

- Material and Finish
  - Shell: see part number break down
  - Insulator: LCP/N/A
  - Contacts: gold alloy / unplated
  - Pre-tinned PC tails: coated with Sn63Pb37 or Sn60Pb40 tin-lead
  - Hardware: passivated stainless steel
- Inspect and Test IAW MIL-DTL-32139
- Interface dimensions per MIL-DTL-32139/3 and /4

PERFORMANCE SPECIFICATIONS
<b>Contact Spacing:</b> .025" (0.64) contact centers
<b>Current Rating:</b> 1 AMP maximum tested per EIA-364-70
<b>DWV:</b> 250 VAC RMS sea level, 100 VAC RMS 70,000 feet per EIA-364 Procedure 20
<b>Insulation Resistance:</b> 5000 Megohms minimum test voltage 100 VDC, per EIA-364 Procedure 21
<b>Operating Temperature:</b> -55° C. to +125° C.
<b>Contact Resistance:</b> 71 millivolt drop maximum, 1 AMP current, any catalog supported wire type
<b>Vibration:</b> 20 g's, IAW EIA-364-28, Condition IV
<b>Shock:</b> 100 g's, IAW EIA-364-27, Condition G
<b>Durability:</b> 200 mating cycles per test procedure EIA-364-09
<b>Corrosion Resistance:</b> 48 hours salt spray IAW EIA-364-26, Condition B
<b>Humidity:</b> 240 hours, IAW EIA-364-31, Test Condition B
<b>Contact Engaging/Separation Force:</b> 5 ounce maximum, 0.4 ounce minimum
<b>Thermal Vacuum Outgassing:</b> Total mass loss (TML) 1.0% max., volatile condensable material (VCM) 0.1% max. IAW ASTM E595

# SERIES 89 NANOMINIATURE Dual-Row Rectangular Connectors



## 891-019 and 891-020 Right-Angle Surface Mount PCB Connector with Jackscrews

### DIMENSIONS

#### 891-019 Plug (Pin) Connectors

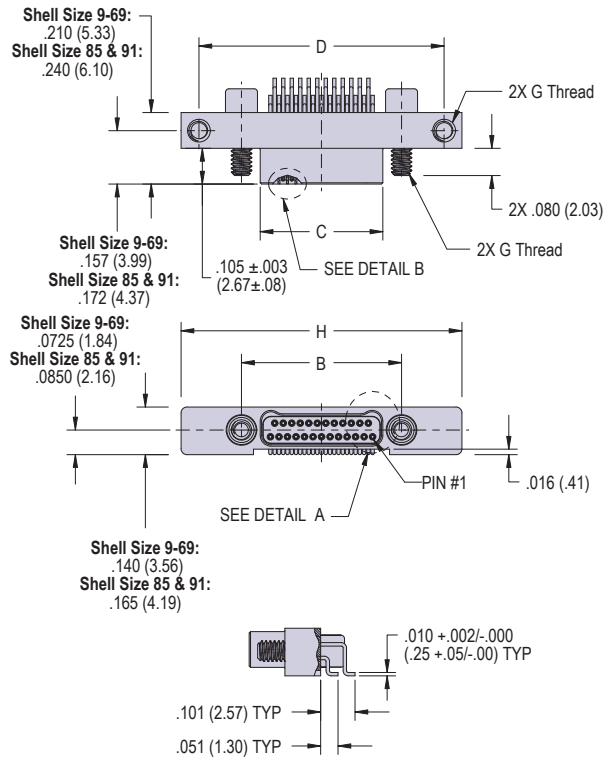

#### 891-020 Receptacle (Socket) Connectors

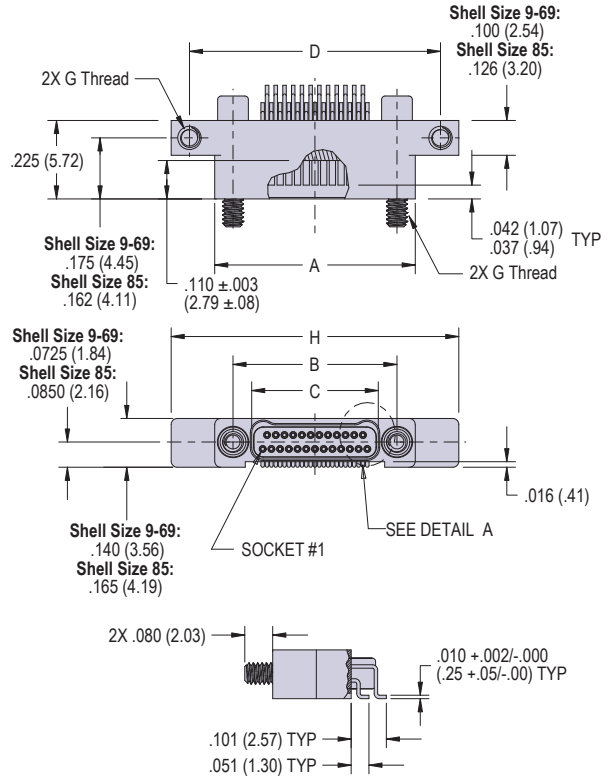

Layout	A	B BSC.	C BSC.	D	G Thread	H
9P	--	.270 (6.86)	.160 (4.06)	.520 (13.21)	#0-80 UNF	.625 (15.88)
9S	.375 (9.53)	.270 (6.86)	.163 (4.14)	.520 (13.21)	#0-80 UNF	.625 (15.88)
15P	--	.345 (8.76)	.235 (5.97)	.595 (15.11)	#0-80 UNF	.700 (17.78)
15S	.450 (11.43)	.345 (8.76)	.238 (6.05)	.595 (15.11)	#0-80 UNF	.700 (17.78)
21P	--	.420 (10.67)	.310 (7.87)	.670 (17.02)	#0-80 UNF	.775 (19.69)
21S	.525 (13.34)	.420 (10.67)	.313 (7.95)	.670 (17.02)	#0-80 UNF	.775 (19.69)
25P	--	.470 (11.94)	.360 (9.14)	.720 (18.29)	#0-80 UNF	.825 (20.96)
25S	.575 (14.61)	.470 (11.94)	.363 (9.22)	.720 (18.29)	#0-80 UNF	.825 (20.96)
31P	--	.545 (13.84)	.435 (11.05)	.795 (20.19)	#0-80 UNF	.900 (22.86)
31S	.650 (16.51)	.545 (13.84)	.438 (11.13)	.795 (20.19)	#0-80 UNF	.900 (22.86)
37P	--	.620 (15.75)	.510 (12.95)	.870 (22.10)	#0-80 UNF	.975 (24.77)
37S	.725 (18.42)	.620 (15.75)	.513 (13.03)	.870 (22.10)	#0-80 UNF	.975 (24.77)
41P	--	.670 (17.02)	.560 (14.22)	.920 (23.37)	#0-80 UNF	1.025 (26.04)
41S	.775 (19.69)	.670 (17.02)	.563 (14.30)	.920 (23.37)	#0-80 UNF	1.025 (26.04)
51P	--	.795 (20.19)	.685 (17.40)	1.045 (26.54)	#0-80 UNF	1.150 (29.21)
51S	.900 (22.86)	.795 (20.19)	.688 (17.48)	1.045 (26.54)	#0-80 UNF	1.150 (29.21)
65P	--	.970 (24.64)	.860 (21.84)	1.220 (30.99)	#0-80 UNF	1.325 (33.66)
65S	1.075 (27.31)	.970 (24.64)	.863 (21.92)	1.220 (30.99)	#0-80 UNF	1.325 (33.66)
69P	--	1.020 (25.91)	.910 (23.11)	1.270 (32.26)	#0-80 UNF	1.375 (34.93)
69S	1.125 (28.58)	1.020 (25.91)	.913 (23.19)	1.270 (32.26)	#0-80 UNF	1.375 (34.93)
85P	--	1.246 (31.65)	1.110 (28.19)	1.546 (39.27)	#2-56 UNC	1.679 (42.65)
85S	1.377 (34.98)	1.246 (31.65)	1.113 (28.27)	1.546 (39.27)	#2-56 UNC	1.679 (42.65)
91P	--	1.321 (33.55)	1.185 (30.10)	1.621 (41.17)	#2-56 UNC	1.754 (44.55)
91S	1.452 (36.88)	1.321 (33.55)	1.188 (30.18)	1.621 (41.17)	#2-56 UNC	1.754 (44.55)

DUAL-ROW RECTANGULAR CONNECTORS

# SERIES 89 NANOMINIATURE Dual-Row Rectangular Connectors



## 891-019 Right-Angle Surface Mount PCB with Jackscrews - Plug Pad Footprint

DUAL-ROW RECTANGULAR CONNECTORS

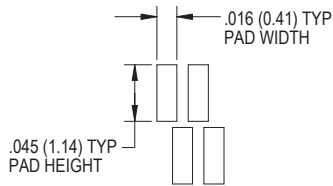

PAD FOOTPRINT DETAIL

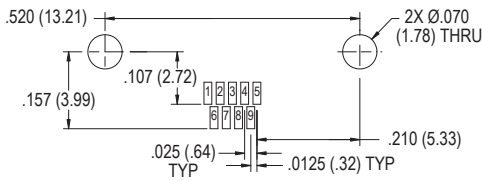
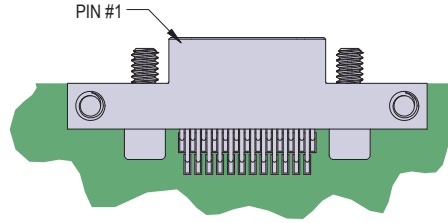

9 Contacts

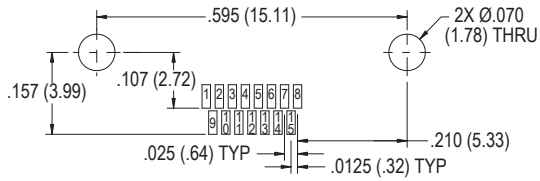

15 Contacts

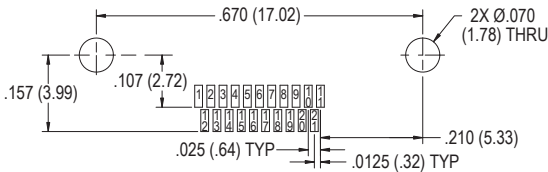

21 Contacts

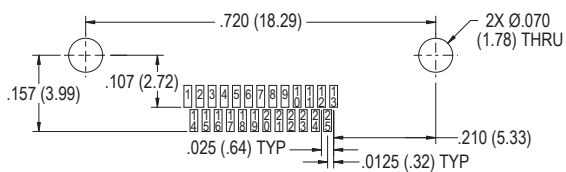

25 Contacts

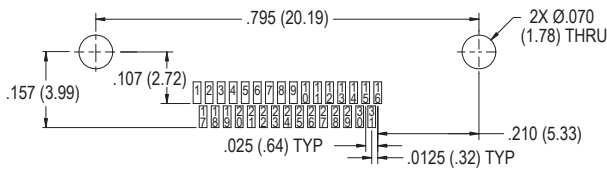

31 Contacts

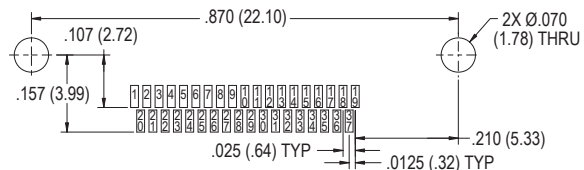

37 Contacts

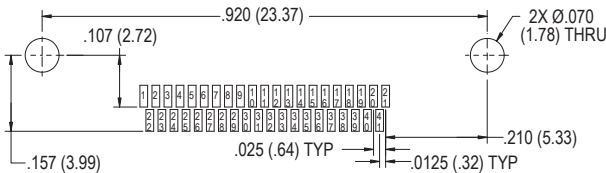

41 Contacts

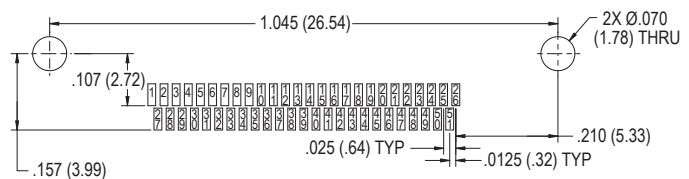

51 Contacts

Layouts shown are for connector mounting side of PC Board.

# SERIES 89 NANOMINIATURE Dual-Row Rectangular Connectors



## 891-019 Right-Angle Surface Mount PCB with Jackscrews - Plug Pad Footprint

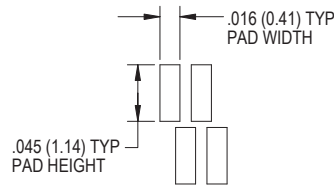

PAD FOOTPRINT DETAIL

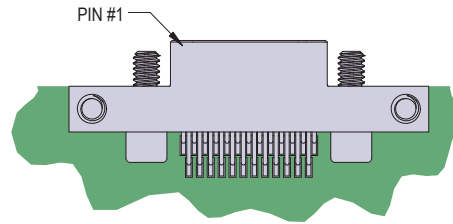

DUAL-ROW RECTANGULAR CONNECTORS

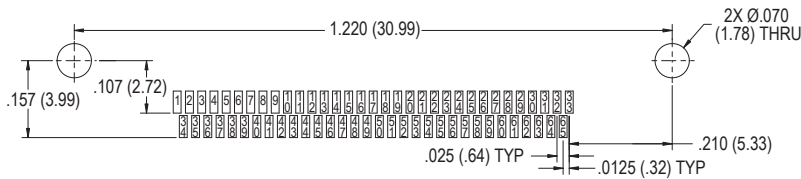

### 65 Contacts



### 69 Contacts

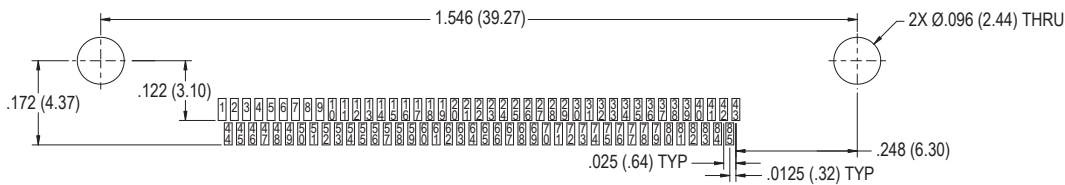

### 85 Contacts

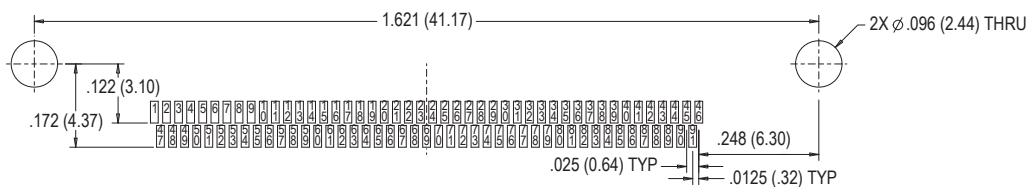

### 91 Contacts

Layouts shown are for connector mounting side of PC Board.

# SERIES 89 NANOMINIATURE Dual-Row Rectangular Connectors



## 891-020 Right-Angle Surface Mount PCB with Jackscrews - Receptacle Pad Footprint

DUAL-ROW RECTANGULAR CONNECTORS

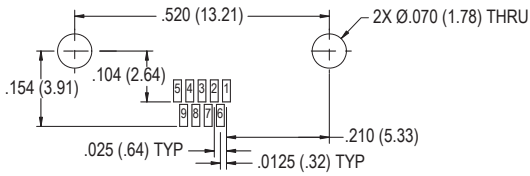
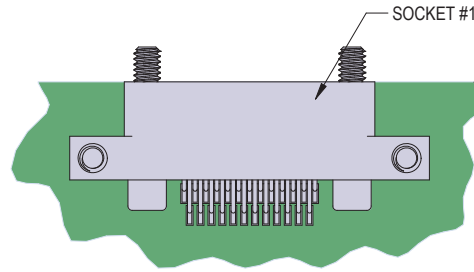
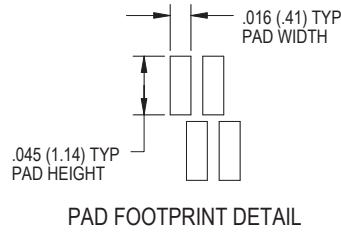

### 9 Contacts

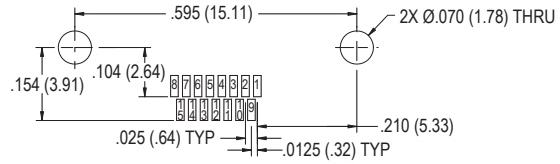

### 15 Contacts

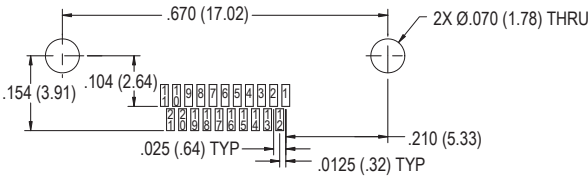

### 21 Contacts

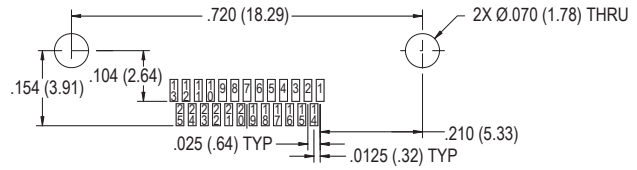

### 25 Contacts

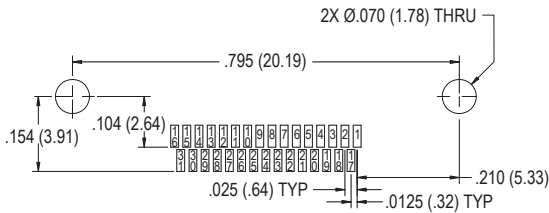

### 31 Contacts

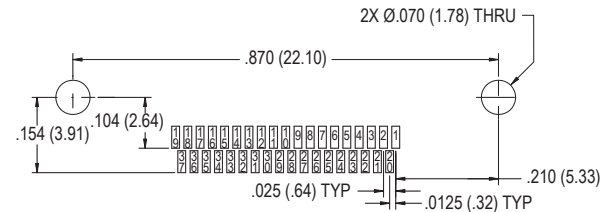

### 37 Contacts

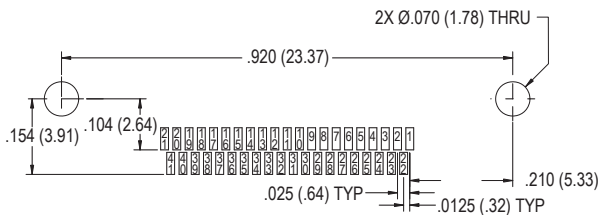

### 41 Contacts

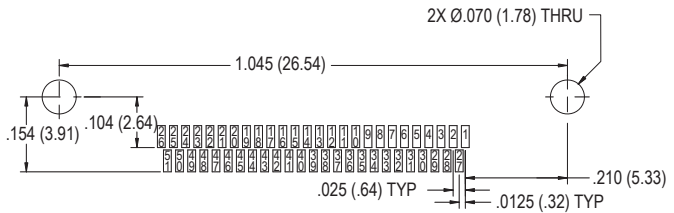

### 51 Contacts

Layouts shown are for connector mounting side of PC Board.

# SERIES 89 NANOMINIATURE Dual-Row Rectangular Connectors



## 891-020 Right-Angle Surface Mount PCB with Jackscrews - Receptacle Pad Footprint

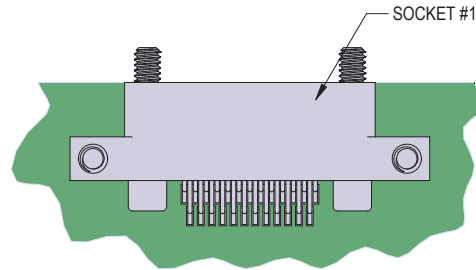
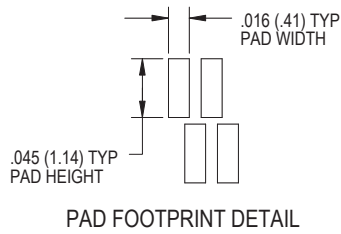

DUAL-ROW RECTANGULAR CONNECTORS

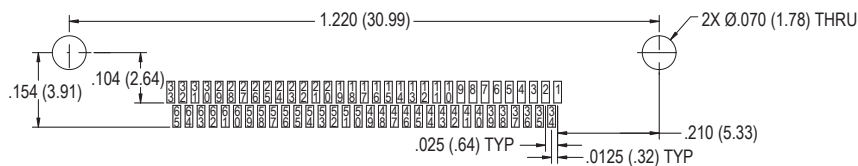

### 65 Contacts

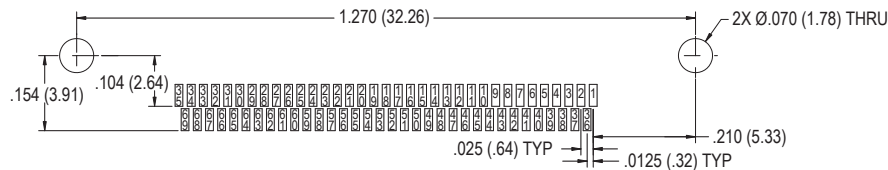

### 69 Contacts

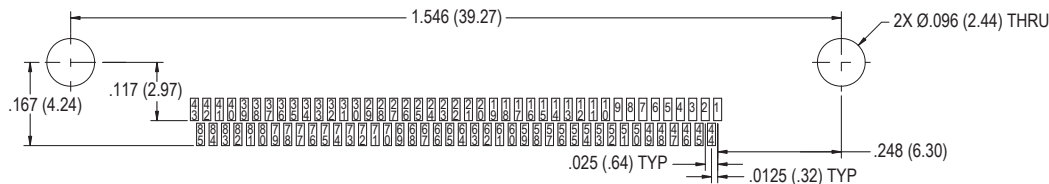

### 85 Contacts

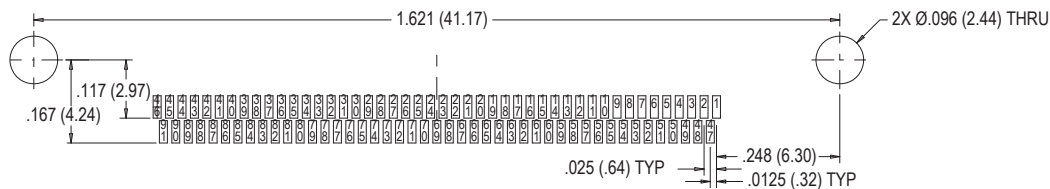

### 91 Contacts

Layouts shown are for connector mounting side of PC Board.