

QwikConnect

GLENAIR • JULY 2022 • VOLUME 26 • NUMBER 3

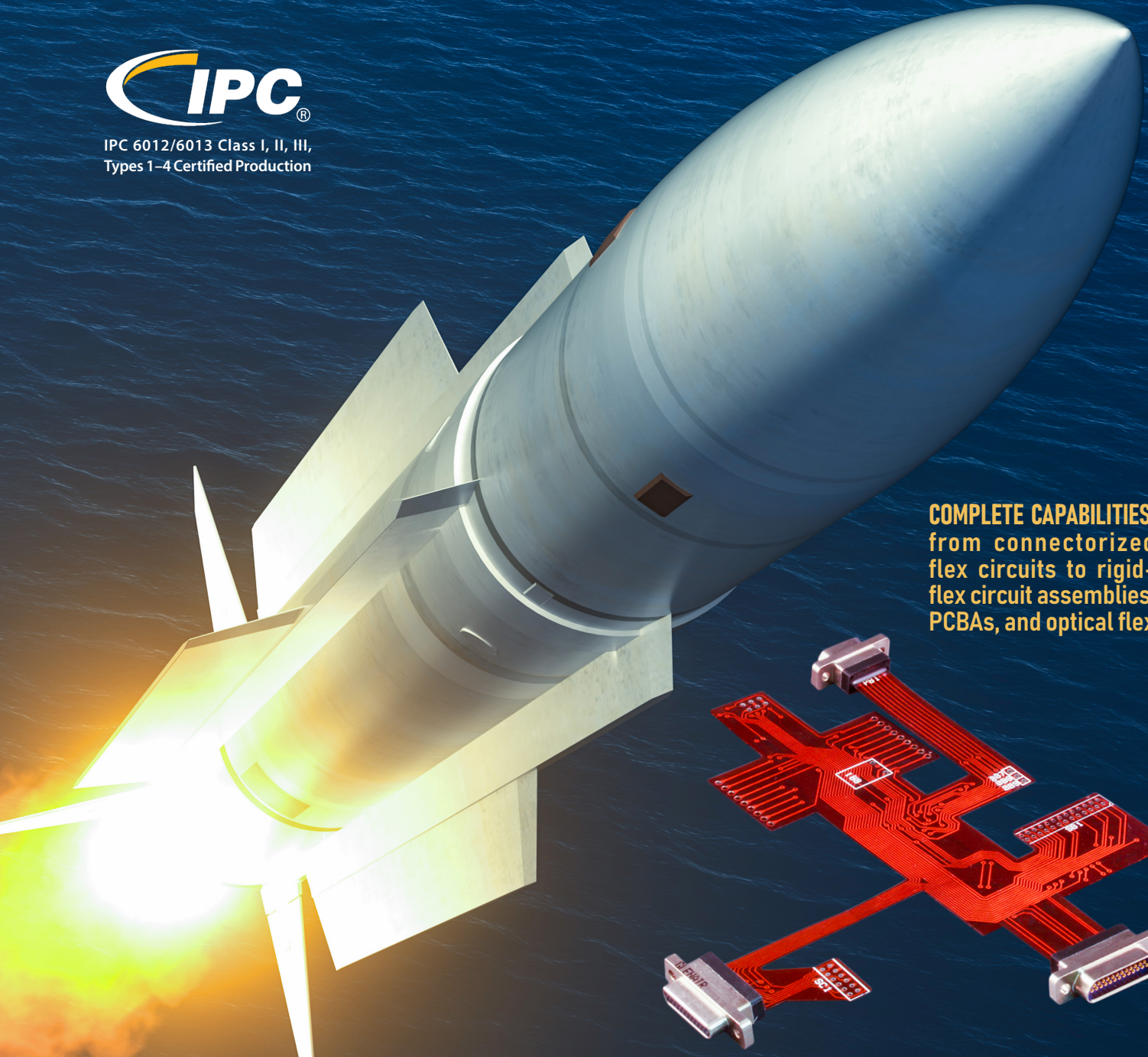

IPC 6012/6013 Class I, II, III,
Types 1-4 Certified Production



COMPLETE CAPABILITIES:
from connectorized
flex circuits to rigid-
flex circuit assemblies,
PCBAs, and optical flex



NEW DIRECTIONS IN
Flex & Rigid-Flex Assemblies

NEW DIRECTIONS IN

Integrated Flex, Rigid-Flex, and PCBAs

Various formats of flex circuits (metallic layer(s) of traces, usually copper, bonded to a dielectric layer, like polyimide)—are used to interconnect embedded electronic packages, displays, backplanes and other PCB components. Flex and rigid-flex circuits are considered superior to conventional wiring as they can be easily routed in three dimensions, are lighter and smaller than discrete wires, and offer virtually unlimited flex cycles in articulated applications. Flex and rigid-flex circuits are commonly deployed within avionic LRU's and other complex electronic systems, as well as between articulating components, such as disk drive, robotic arms, and other electro-mechanical devices.

Compared with traditional wiring, compact flexible printed circuit assemblies reduce system complexity and assembly time as well as enhance reliability. Due to their low mass and high circuit density, flex circuit assemblies are less susceptible to impact and vibration damage than conventional wire harness assemblies, making them an ideal choice in satellite applications such as articulated solar arrays, sensors, and antenna.

As mentioned, the high electrical-connection density provided by flex and rigid-flex circuits delivers considerable weight and package size savings compared to wire and wire harnesses. This makes the medium an ideal choice for the reduction of all-up weights in aircraft and space systems. For this reason, flexible printed circuits are increasingly specified in place of conventional interconnect wire harnesses in weight-sensitive aero and space applications.

Single-sided flex circuits

Single-sided flexible circuits are the most common type manufactured by Glenair. They consist of a single conductor layer on a flexible dielectric film terminated with a thru-hole, ZIF or surface mount PCB connector. Single-sided flex circuits may be supplied as complex multi-branch assemblies. Or more commonly as simple point-to-point flex jumpers, such as from a board-level connector to an I/O interface connector. Glenair offers numerous point-to-point flex jumpers as standard catalog products with accelerated lead times.

Glenair is one of the few manufacturers of turnkey, connectorized flex assemblies that will soon be making long length assemblies 96 inches and up. Glenair will offer these extra-long flex circuits in one



Flex and rigid-flex circuits are ideally suited for 3-D routing requirements in small form-factor electronics

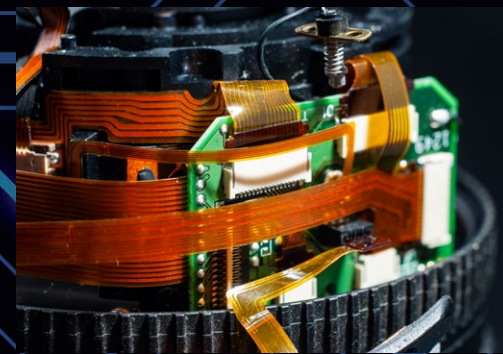

continuous piece. Long assemblies of this type may be employed as replacements for complex multibranch EWIS wiring in commercial and military aircraft.

Double-sided flex circuits

Double-sided flex is also supplied to expand available circuit real-estate within the same basic envelope as a single-sided assembly. Connector terminations for double sided flex include straddle-mount designs for interconnection to conductive pads on both sides of the flexible dielectric film.

Multilayer flex circuits

Multilayer flex is supplied for applications that need three or more layers of conductors for termination to higher pin-count circular and multi-row rectangular connectors. These assemblies support their higher circuit density with bonded conductive layers that are interconnected with selectively plated through-holes called "vias." Glenair can support up to 8 such layers in a conventional multilayer flex circuit build.

Rigid-Flex circuits

Rigid-Flex Circuits are hybrid constructions that consist of flexible circuit assemblies, laminated together with rigid board elements. Rigid-Flex circuits are used for surface mounting of electronic components or to provide strengthening or mounting features to the flex assembly. Glenair manufactures numerous variations of rigid-flex, including multi-layer assemblies with up to 27 layers. Rigid-Flex assemblies are also uniquely employed on flex-to-install designs that combine embedded PCB boards and flex circuitry. Supported connector terminations include thru

hole, straddle, surface mount, and ZIF. Substrate options include DuPont™

Kapton® and Panasonic Felios.



Optical Flex Circuits

Glenair **optical flex circuit assemblies** are lighter weight, higher density replacements for conventional fiber wire assemblies. Typically integrated with high-density MT ferrule terminations, the assemblies are designed for use with optical backplanes and card-to-card applications. Glenair optical flex circuit support singlemode, multimode, and specialty fiber as well as hybrid optical and electrical configurations that integrate the two technologies in multilayer assemblies.

The principal design benefit of optical flex circuitry is the ability to implement fiber crossing or shuffle circuitry for the complex routing of fiber lines inside control computers and other types of LRUs. Glenair optical fiber circuit assemblies offer reduced installation time and termination errors, reliable, repeatable performance, superior optical fiber management, controlled low-skew routing lengths, controlled bend radii minimizing bend loss, and long length leads 12 inches and up, eliminating the need for splicing within an equipment enclosure. Glenair long-length leads are far more durable than conventional fiber ribbon cable when used in support of MT ferrules and connectors.

For all assemblies, Glenair builds in accordance with the IPC-6012/6013 specification standard, although Military customers may alternatively cite specifications IAW MIL-PRF-31032. In both cases, we recommend leveraging our design team for optimization of connector pin-outs to reduce frequency of cross-overs that lead to higher layer counts and increased cost. Our application design and prototyping services are free and highly available.

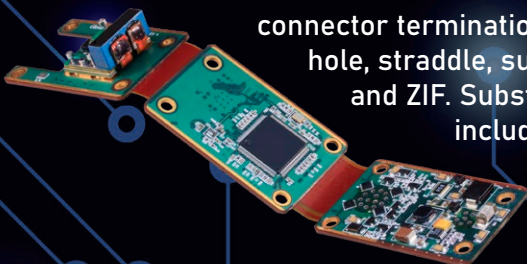

MISSION-CRITICAL
FLEX & RIGID-FLEX CIRCUITS
Markets Served

Commercial Aerospace



Aerospace-grade
rigid-flex
circuit assembly



Glenair flex circuit interconnect assemblies for commercial aerospace applications are fabricated in accordance with the highest IPC assembly standards, and equipped with connectors, contacts, and termination designs suitable for use in avionics and other commercial aerospace LRU equipment. Assemblies are optimized for reliable life-of-system performance in pressurized aircraft applications characterized by such stress factors as vibration, shock, temperature extremes, and rough handling. PCB assembly materials are RoHS and REACH compliant.

**TURNKEY CONNECTORIZED
FLEX CIRCUIT ASSEMBLIES**

Optimized for Harsh Aerospace Applications



Crimp-contact Series 79
for standard signal, power,
high-speed and RF



Series 23 "better than QPL"
SuperNine environmental
and hermetic circular



Micro miniature Mighty Mouse
and Series 806 Mil-Aero for size
and weight reduction

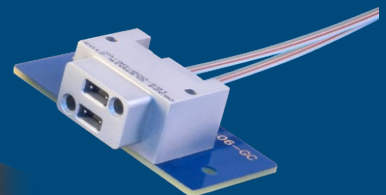

Vita 66.1 and 66.4 optical
backplane connector
optimized for optical flex

ADVANTAGES OF FLEX CIRCUITRY
FOR AEROSPACE APPLICATIONS:

High-Density Size and Weight Savings

- Save size, weight, and improve density compared to wire bundles
- Flexible, repeatable routing for complex 3-dimensional installations
- Broadest range of high-performance I/O and board connectors
- Optimized reliability: high-speed, high temp, high shock and vibrate

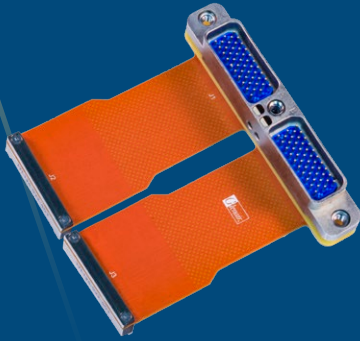

Example of a simple rigid-flex application with mounting point stiffeners added

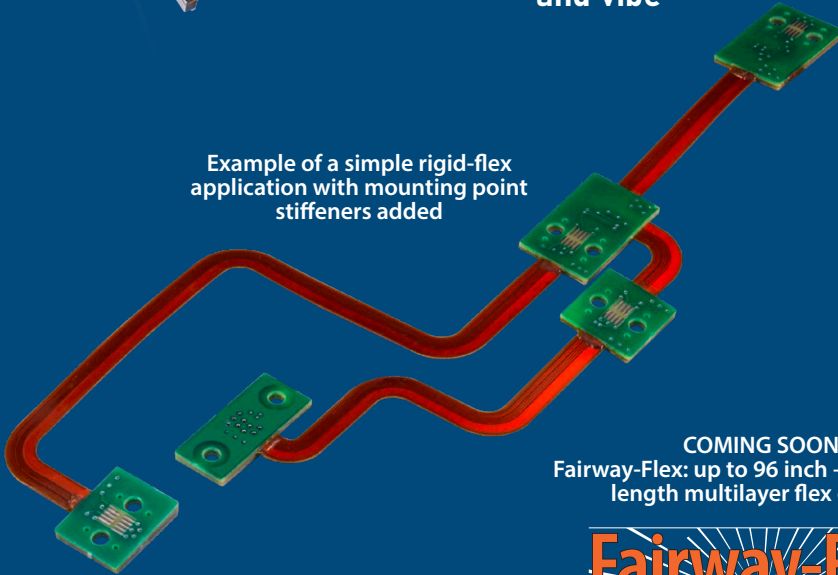

COMING SOON
Fairway-Flex: up to 96 inch + continuous length multilayer flex circuits

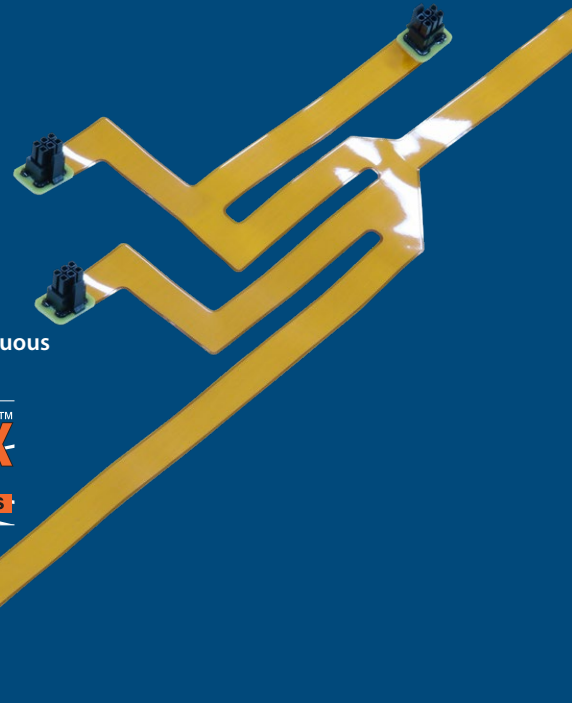

Series 23 SuperNine and Micro-D flex assembly with discrete RF Coax lines for use in a Zone 2 avionics application



Flex assembly with Series 79 I/O connector and wide flex circuit traces for medium current transmission

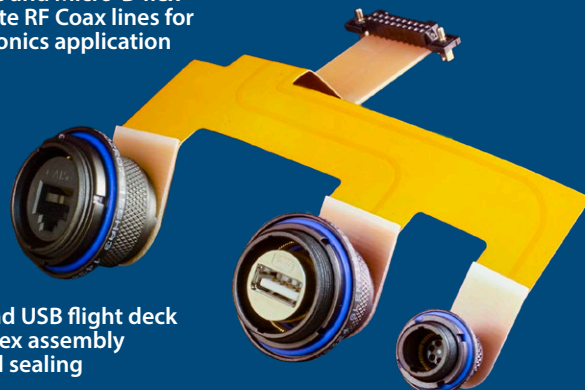

Unique Ethernet and USB flight deck multibranch flex assembly with panel sealing

MISSION-CRITICAL
FLEX & RIGID-FLEX CIRCUITS
Markets Served

Military Defense

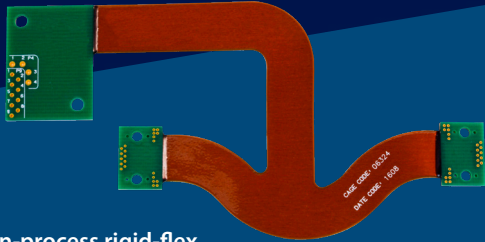

In-process rigid-flex circuit, ready for PCB connector termination



IPC 6012/6013 Class I, II, III,
Types 1–4 Certified Production



Glenair's flex circuit assembly cell is IPC 6012 / 6013 Class I, II, III, types 1–4, ISO 9001, and AS9100 certified. Glenair flex and rigid-flex assemblies utilize high-performance polyimide PCB materials. Standard FR-4 board assemblies are also available. All connectors used in the flex and rigid-flex assemblies meet or exceed military requirements for shock, vibration, corrosion resistance, environmental sealing, and shielding performance. All assemblies are optimized for size and weight reduction, as well as superior performance in high-speed, RF, and high-bandwidth optical applications.

LIGHTWEIGHT, SMALL FORM-FACTOR ASSEMBLIES Optimized for **Military / Defense Applications**

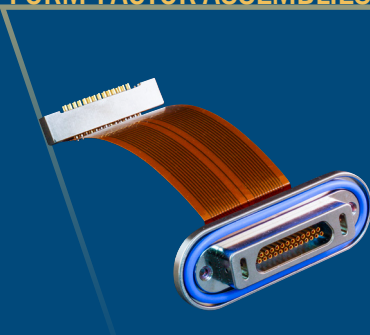

Micro-D subminiature I/O connector to AlphaLink board connector assembly

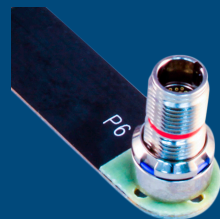

Nanominiature Series 88 SuperFly flex jumper



Series 79 Micro-Crimp flex assembly with hybrid signal and power contacts

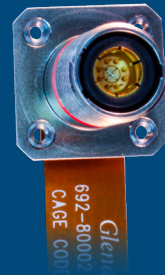

High-speed 10GbE flex assembly with El Ochito® datalink contact

**OPTIMIZED
SPACE-SAVING**

Packaging and Integration

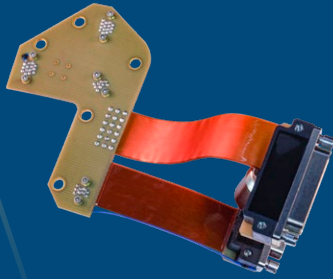

Stacked Micro-D I/O connectors with flex and rigid-flex circuitry

Flex and rigid-flex circuit assemblies are ideal for space-constrained electronic packages and enclosures, or for interconnect systems that are required to flex in 3 axes during normal use. Flex and rigid-flex circuitry offers complete freedom to design boards and wiring for even the most densely-packed electronic enclosures. In mission-critical applications, the ability to reduce or even eliminate discrete wiring and FR-4 boards in favor of flex circuitry helps military defense application designers make the most efficient use of available space.

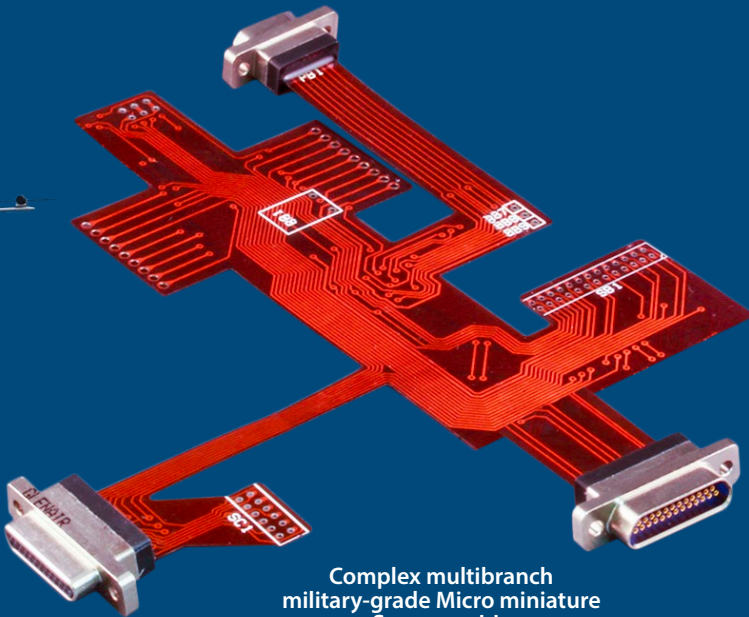

Complex multibranch military-grade Micro miniature flex assembly

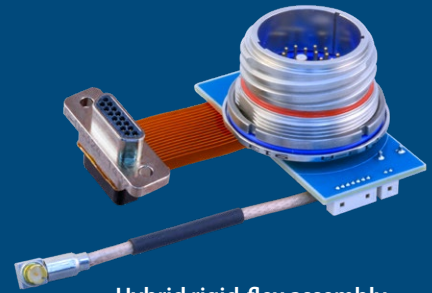

Hybrid rigid-flex assembly with RF coaxial cable and hermetic I/O connector

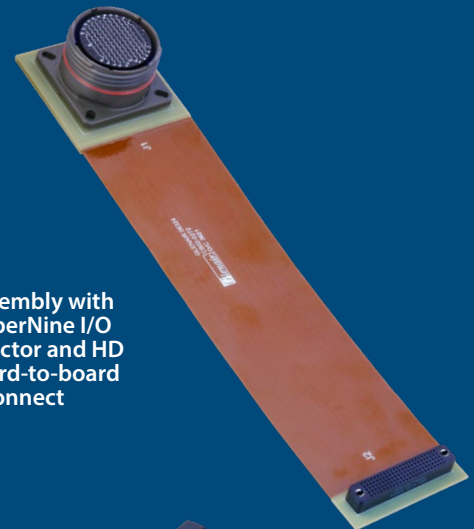

Jumper assembly with Glenair SuperNine I/O panel connector and HD Stacker board-to-board interconnect

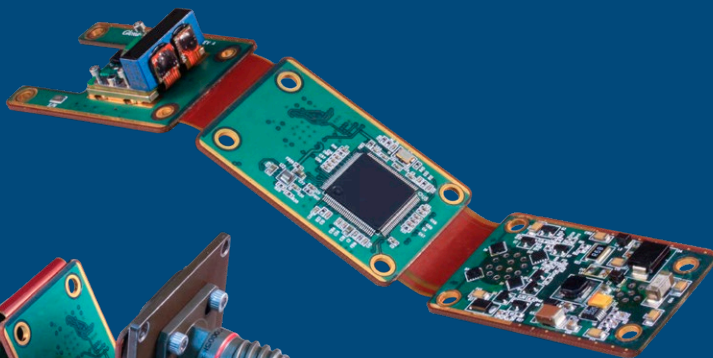

Unique-design PCBA with flex-to-install element

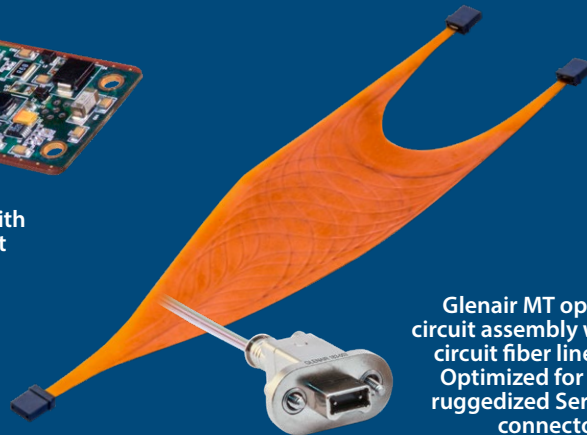
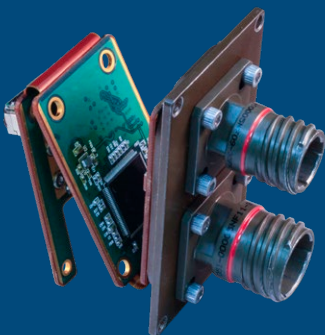

Glenair MT optical flex circuit assembly with shuffle circuit fiber line routing. Optimized for use with ruggedized Series 79 MT connectors.

MISSION-CRITICAL
FLEX & RIGID-FLEX CIRCUITS
Markets Served

Downhole Oil & Gas



Point-to-point rigid-flex assembly for a downhole tool application

Temperature-tolerant micro miniature flex circuit assemblies manufactured by Glenair are ideally suited for use in modular electronic transmission and sensor tools used as aids in directional drilling and geologic formation evaluation. Flex and rigid-flex circuit board assemblies terminated with Glenair Micro-D, Nanominiature, and special high-temperature Well-Master Micro-D PCB connectors are applied in applications as diverse as Measurement While Drilling (MWD), Logging While Drilling (LWD), slick line production tools, and other harsh downhole applications.

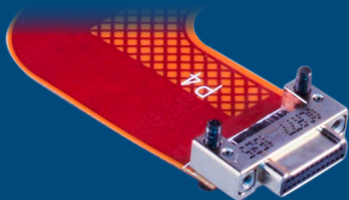

Glenair Nanominiature PCB connector: ultra high-density .025\"/>



Glenair Micro-D subminiature PCB connector: micro high-density .050\"/>

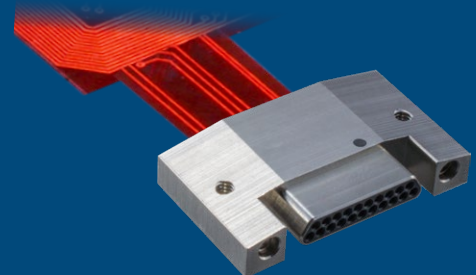

Glenair Well-Master 260° Micro-D PCB header with unique angled mounting ears and high temperature tolerance

ADVANTAGES OF FLEX CIRCUITRY FOR DOWNHOLE APPLICATIONS:

Optimal Harsh Environment Performance

- Withstands high levels of drilling shock and vibration
- Broad temperature tolerance
- Available non-magnetic materials
- Available 260°C low-profile PCB connectors
- Optimized reliability: high-speed, high-temp, high shock
- Ideally suited for double-sided component mounting
- Integration of active componentry



PROVEN PERFORMANCE DOWNHOLE

Connectorized PCB Flex Assembly Designs

Major Tool Types:

- MWD (Measurement While Drilling)
- LWD (Logging While Drilling)
- Wireline Logging
- Slickline Tools – Production
- Distributed Temperature Sensing (DTS)
- Pressure Temperature Sensing (PTS)
- Gamma Sensor

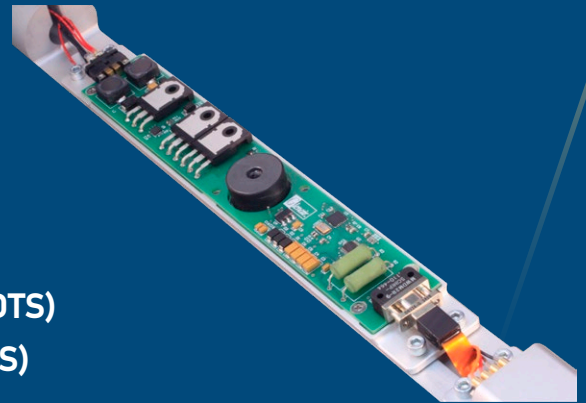

High-speed Glenair cylindrical PCB connector used in a tool segment interconnection flex jumper assembly

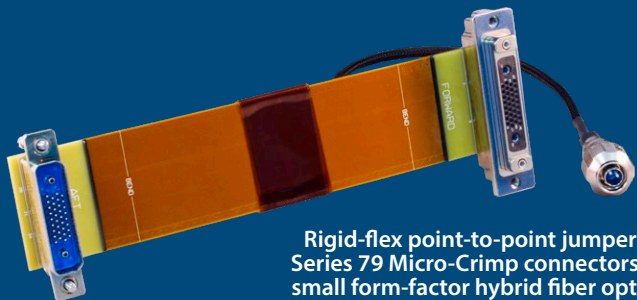

Rigid-flex point-to-point jumper with Series 79 Micro-Crimp connectors and a small form-factor hybrid fiber optic tool segment connector

Micro-D subminiature hybrid flex jumper with signal and power circuits

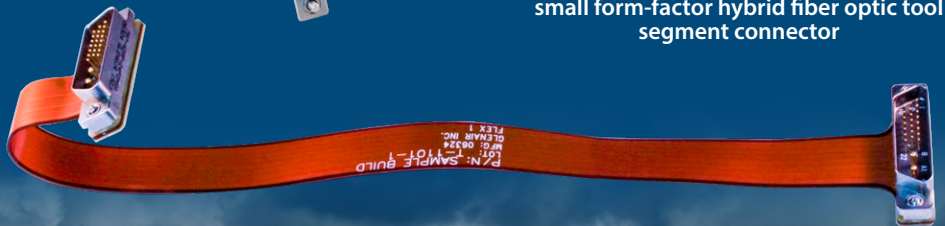

MISSION-CRITICAL
FLEX & RIGID-FLEX CIRCUITS
Markets Served

Space Vehicles



Space-grade rigid-flex circuit assembly



Ultra lightweight flex circuit assemblies manufactured by Glenair have traveled to and from orbit dozens of times on NASA and ESA platforms as well as on numerous commercial space-launch vehicles and satellites.

Glenair connectorized flex circuit assemblies are available in configurations optimized for space with inherently radiation-resistant materials, NASA EEE-INST-002 screening, and lot traceability.

Space-grade FPC assembly for a GEO satellite application

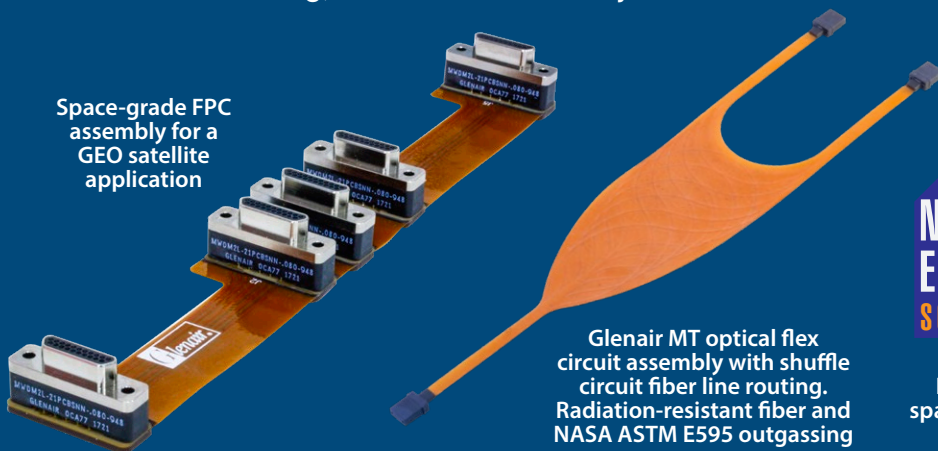

Glenair MT optical flex circuit assembly with shuffle circuit fiber line routing. Radiation-resistant fiber and NASA ASTM E595 outgassing



Inherently radiation-resistant materials, space agency screening, Class G space-grade interconnects, and lot traceability

ADVANTAGES OF FLEX CIRCUITRY FOR SPACE APPLICATIONS:

Optimal Size and Weight Reduction

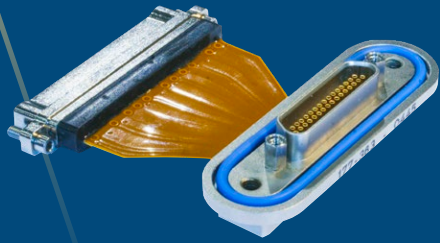

- Withstands high levels of launch shock and vibration
- Broad temperature tolerance
- Inherently radiation-resistant materials including optical flex
- NASA screening and lot traceability
- TRL 9 with space agency and commercial flight legacy

TECHNICAL READINESS LEVEL TRL 9

Connectorized PCB Flex Assembly Designs



Space-grade Series 28 HiPer-D to Series 80 Mighty Mouse I/O jumper



EMI/RFI filtered power transmission flex circuit assembly

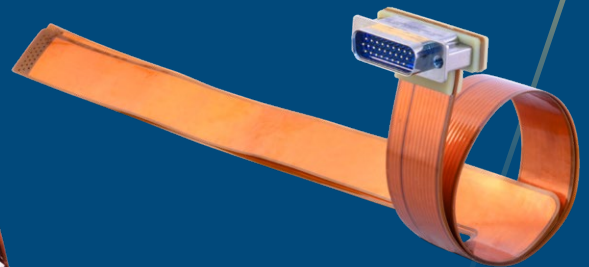

"Clock spring" assembly with HiPer-D I/O connector for a satellite solar array actuator



Space-grade connectorized jumper assemblies

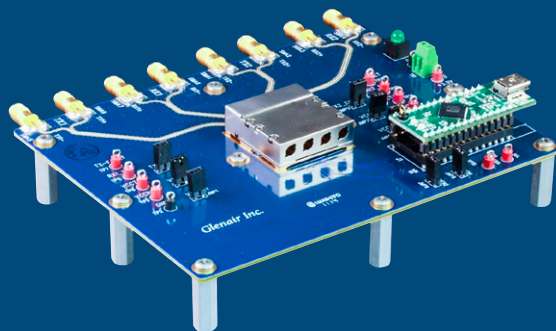

Rigid board assemblies with surface-mount components

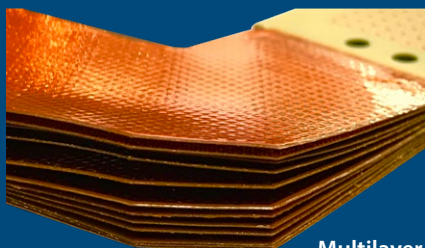

Multilayer flex and rigid-flex assemblies

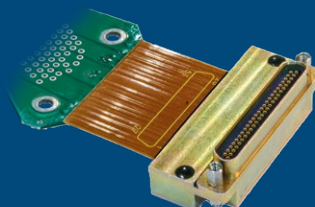

Rigid-flex Micro-D assembly with potted strain relief

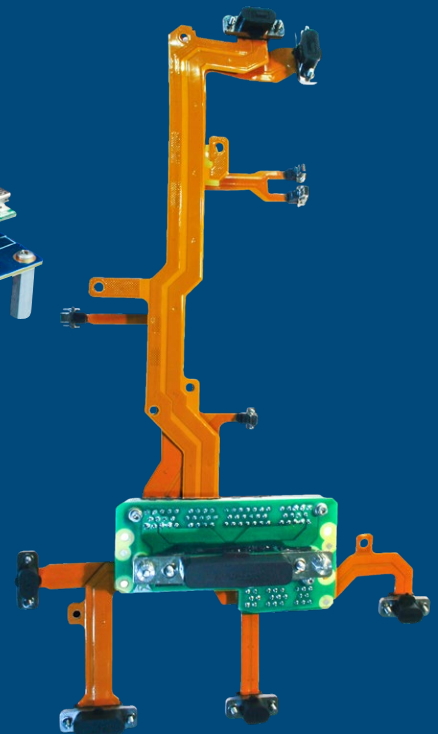

Hybrid rigid/flex assemblies

FLEX AND RIGID-FLEX Specification Standards



GLENAIR FLEX
AND RIGID-FLEX



IPC 6012/6013 Class I, II, III,
Types 1-4 Certified Production

Manufacturing Formats and Specifications

The following tables describe, in brief, Glenair flex and rigid-flex manufacturing formats and specifications. Glenair recommends commercial customers specify IPC-6012/6013 standards of workmanship which are fully supported by Glenair. Military customers may alternatively cite specifications IAW MIL-PRF-31032.

FLEX ASSEMBLIES	
Design Formats	PADS • PADS PRO • Pro E / Creo • SolidWorks • Autodesk Inventor • CAM 350 • Altium • Valor • POLAR • XPedition
Manufacturing Formats	DXF • Gerber • ODB++ • IPC 2581
Layer Count	Max typ. up to 8
Termination	Thru hole • Reverse bare • Floating fingers • ZIF • Surface-mount
Conductor Width/Space	Lines: .003" • Spacing: .003" (dependent on copper weight)
Bend Radius (military)	Single Metal Layer: 4-6X overall flex thickness • Double Metal Layers: 6-10X overall flex thickness • Multi Layer Metal: 12-15X overall flex thickness
Materials / Tg	Substrate: DuPont™ Kapton® polyimide flex adhesive and adhesiveless -60°C to 125°C Cover layer: DuPont™ Kapton® Stiffener: FR4 or DuPont™ Kapton® (metal stiffeners available upon request) Conductor: Copper, Constantan High-temperature materials and more available
Surface Finish	ENIG • HASL • Immersion Tin and Silver • Soft and Hard Gold
Specs and Quality Management	IPC-6013 Class I, II, III, types 1-3 • ISO 9001, AS 9100J-STD-001 Space

RIGID-FLEX ASSEMBLIES	
Design Formats	PADS • PADS PRO • Pro E / Creo • SolidWorks • Autodesk Inventor • CAM 350 • Altium • Valor • POLAR • XPedition
Manufacturing Formats	DXF • Gerber • ODB++ • IPC 2581
Max Panel Thickness	Range of thicknesses from .010" to as thick as .250"
Layer Count	27 +
Via Technology	Blind, buried • Thru hole • Filled (conductive and non-conductive)
Conductor Width/Space	Lines: .003" • Spacing: .003" (dependent on copper weight)
Materials / Tg	Substrate: Nelco 4000, Rogers, Megtron, Polyimide, and more
Surface Finish	ENIG • HASL • Immersion Tin and Silver • Soft and Hard Gold
Specs and Quality Management	IPC-6013 Class I, II, III, type 4 • ISO 9001, AS 9100, J-STD-001 Space

DuPont™ and Kapton® are trademarks or registered trademarks of E.I. du Pont de Nemours and Company.

FLEX, RIGID-FLEX, AND RIGID PCB Design Options

STANDARD DESIGN OPTIONS

Properly designed flex and rigid-flex assemblies offer significant space and weight savings compared to wire harnesses. Many design options are available, including integrated stiffeners, shielding, factory forming, selective bonding, termination, layer count and so on.

- 1 Right-angle surface mount Nanominiature plug connector
- 2 Hatch shield and solid copper shield flex
- 3 Series 801 Mighty Mouse receptacle with PC tails
- 4 AlphaLink® SL spring-loaded contact connector
- 5 Cross-hatch shield flex
- 6 Board-mount transceiver
- 7 Series 79 Micro-Crimp® right-angle PCB panel-mount receptacle
- 8 Solid copper shield flex

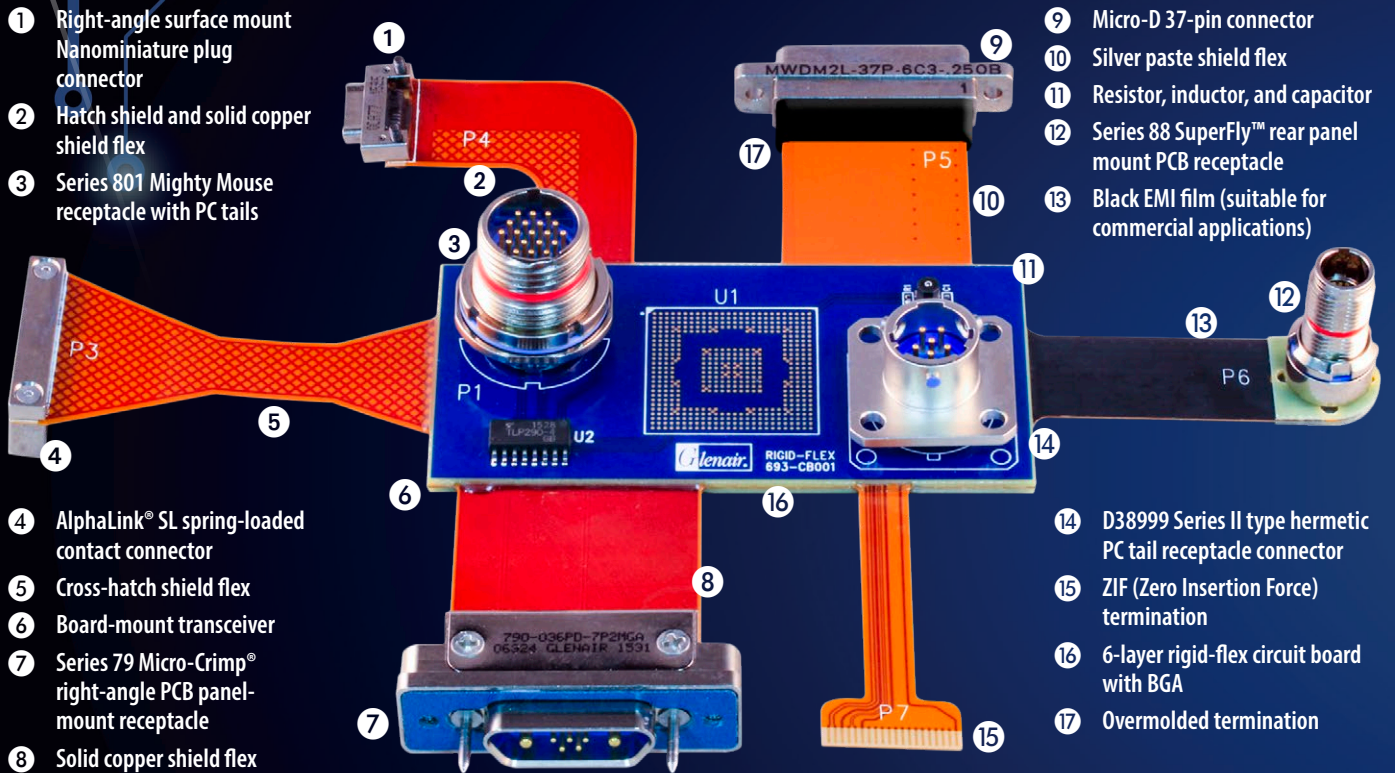

Integrated Flex / Rigid-flex assemblies

- 9 Micro-D 37-pin connector
- 10 Silver paste shield flex
- 11 Resistor, inductor, and capacitor
- 12 Series 88 SuperFly™ rear panel mount PCB receptacle
- 13 Black EMI film (suitable for commercial applications)
- 14 D38999 Series II type hermetic PC tail receptacle connector
- 15 ZIF (Zero Insertion Force) termination
- 16 6-layer rigid-flex circuit board with BGA
- 17 Overmolded termination

SMALL FORM-FACTOR PCBAs AND FLEX-TO-INSTALL ASSEMBLIES

Integrated Design Examples

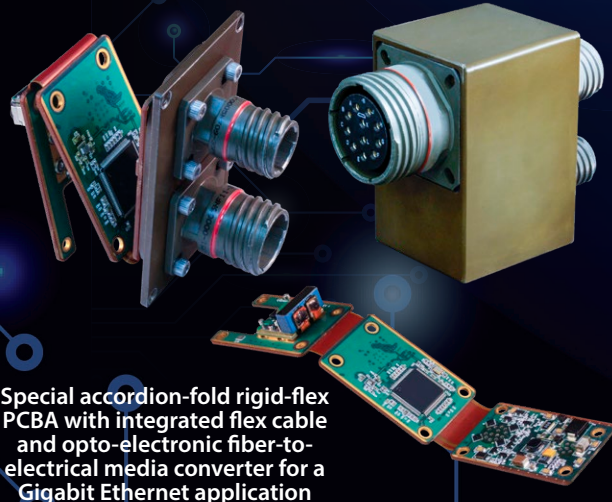

Special accordion-fold rigid-flex PCBA with integrated flex cable and opto-electronic fiber-to-electrical media converter for a Gigabit Ethernet application

Complex double-sided PCBA and interconnect assembly with programmable electronics for a high-speed data aggregation application



Ruggedized FMC connectivity PCBA designed for modular incorporation into Ethernet, Fibrechannel, and/or DVI, SMPTE video system applications

FAST-TURNAROUND MODELING AND PROTOTYPING

SolidWorks - 3D Print Prototypes

MODELING
AND 3D PRINT

Optimized for **Rapid Prototyping**

- 3D representation of flex assemblies using SolidWorks
- 3D printed "paper doll" outline mockups for fit checks with copper clad DuPont™ Kapton® to simulate actual flexibility
- Incorporation of customer-supplied wiring diagram and chassis information in laser-cut mechanical samples

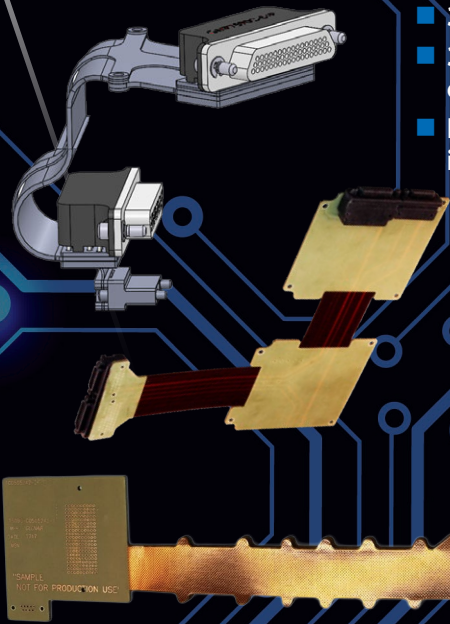

Example SolidWorks and 3D printed paper doll prototype mockups produced by Glenair's Integrated Flex Assembly team—typical turnaround 2–3 days upon receipt of request for most application designs

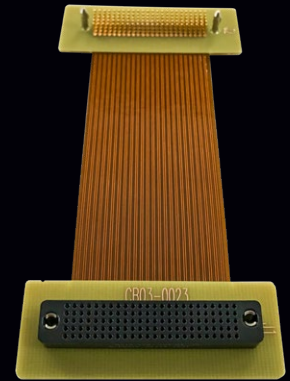

Complimentary quick-turn mockups produced by by Glenair: 28-layer rigid-flex, and 12-layer multibranch rigid-flex

HD Stacker board-to-board connector/flex mockup

3D MODELING OF BOX BUILDS FOR OPTIMAL INTEGRATION OF I/O INTERCONNECTS AND FLEX CIRCUIT ASSEMBLIES

- Customer-supplied STEP file of box with panel cutouts
- Glenair value-added 3D model with connector size and flange modifications

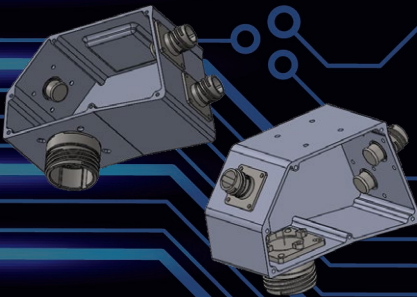

In this example, customer supplied a STEP file of a box enclosure with existing panel cutouts. The Glenair engineering team used SolidWorks to design a specially-modified connector flange, enabling the use of a smaller, higher-density connector, for significant size-and weight-savings.

- Electronic box builds are supported by software-based design and prototyping of I/O connectors and integrated flex circuits
- Process leads to optimized location and routing of internal assembly and I/O interface

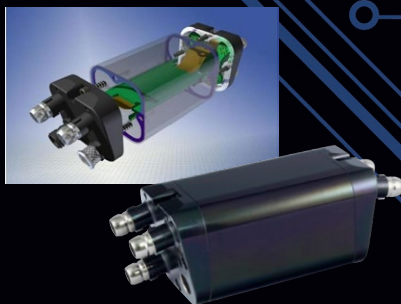

This integrated system enclosure, complete with printed circuitry, I/O connectors, and power modules was designed and modeled in SolidWorks prior to production manufacturing.

DuPont™ and Kapton® are trademarks or registered trademarks of E.I. du Pont de Nemours and Company.

FAST-TURNAROUND MODELING AND PROTOTYPING **QwikConnect** Design and Production Process

GLENAIR

GLENAIR INTEGRATED
PCB/FLEX ENGINEERING

From **Concept** to **Design**

The **mechanical schematic design** process typically takes one of two forms: either the customer presents a fully-realized mechanical design, or as is often the case, the process begins with a “napkin sketch” of the project. Here is an example of just such a rough design that kicked off a rigid-flex circuit assembly development process.

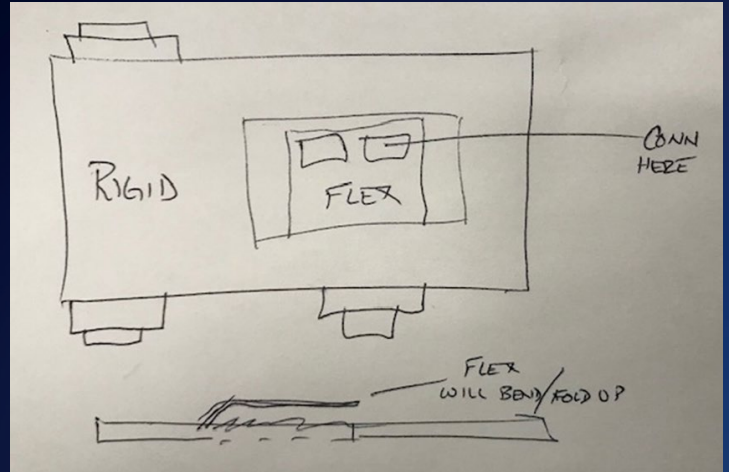

Glenair engineers utilized our **Altium** software to create a functional and problem-free mechanical design for customer review and modification prior to starting the build.

Altium

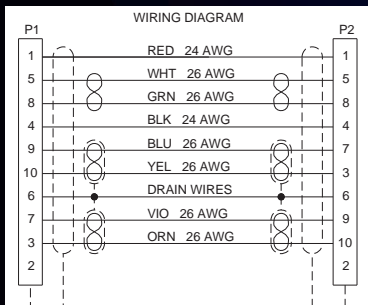
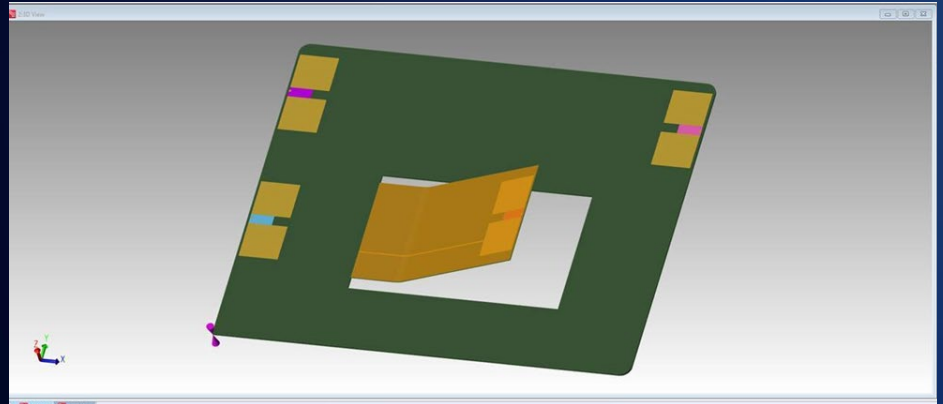

Electricals: The next step is to define the electricals. To approximate layer count, we need a wiring diagram “schematic” complete with signal types, currents, and shielding requirements. This is also used to determine ROM pricing. In this project, work to this point was completed in just 3 weeks. With the final design approved, we were ready for production manufacturing.

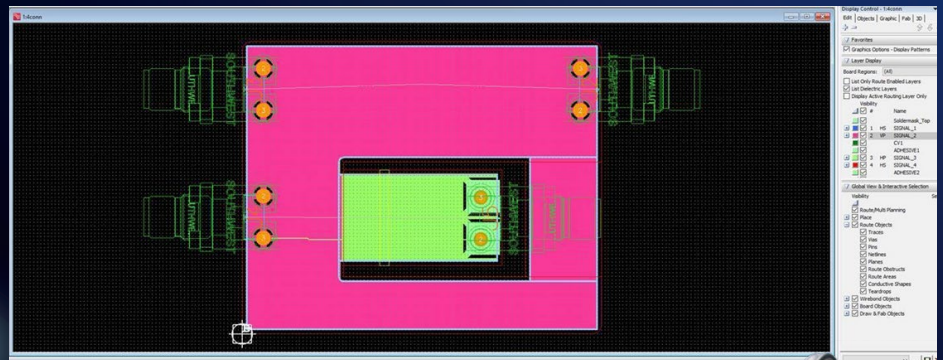

Validation test requirements: Glenair offers complete generation of PCB/flex fabrication data packages including component-level documentation. Most flex customers specify validation testing as a required part of the documentation package. Tests may include DWV/IR, continuity, impedance (eye pattern), and others.

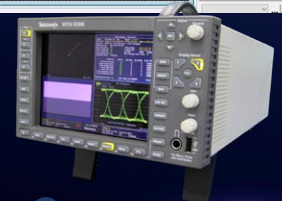

SUFFERIN' SUCCOTASH!
You got 'em
all wrong!



PINK PANTHER



POPEYE



POINDEXTER AND MR. PEABODY



WILMA FLINTSTONE



FRED FLINTSTONE



CHARLIE BROWN



ARNOLD



SQUIDWARD



YOGI BEAR



MR. KRABS



BULLWINKLE



GOOFY



BART SIMPSON



ODIE



BOBBY



MIGHTY MOUSE



REN AND STIMPY



MARVIN THE MARTIAN



DEXTER



TASMANIAN DEVIL



BUGS BUNNY



CASPER



ROAD RUNNER



BETTY BOOP



SNOOPY



OLIVE OYL



PINKY AND THE BRAIN



MARGE SIMPSON



FELIX THE CAT



SPONGEBOB SQUAREPANTS



STEVIE GRIFFIN



MOJO JOJO



DAFFY DUCK

FLEX, RIGID-FLEX, AND RIGID PCB ASSEMBLIES

Application / Design Options

GROUND PLANES AND SHIELDS

Managing EMI emissions and signal line impedance are critical aspects of flex circuit design. Effective use of ground / shield planes, appropriate connector interfaces, and matched-impedance flex circuits delivers optimal high-speed signal integrity.

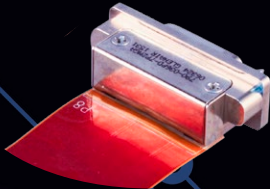

Full copper shield

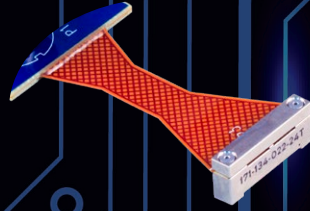

Cross-hatch mesh shield

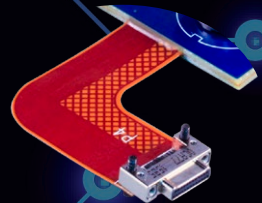

Hybrid solid/mesh



Silver epoxy



Connector-to-flex shielding (soldered pin insert)

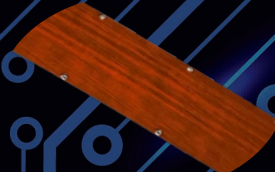

Stitched vias

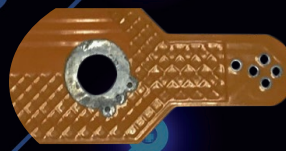

Polyimide-based for contact grounding



Black Tatsua

STRAIN RELIEF OPTIONS FOR FLEX AND RIGID-FLEX



Reinforcing "wings"



Stiffeners at critical assembly points



Reinforced solder joint with potting

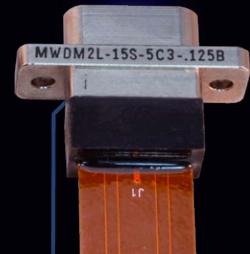

Molded epoxy encapsulant

RIGID-FLEX MOUNTING POINTS FOR IMPROVED VIBRATION AND SHOCK RESISTANCE

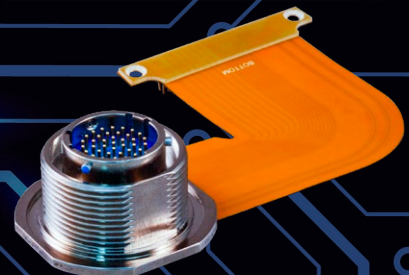
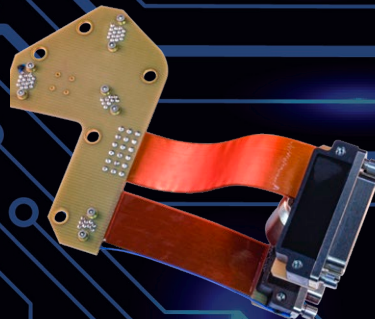
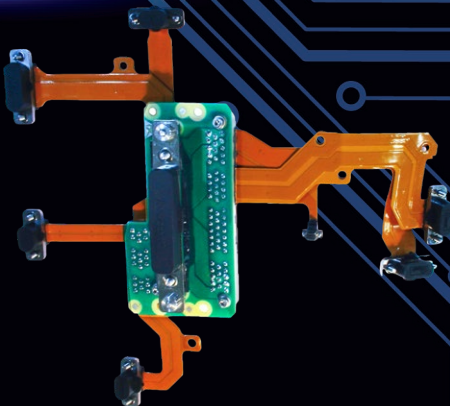

Typical examples of rigid-flex mounting points in connectorized flex circuit assemblies

FLEX, RIGID-FLEX, AND RIGID PCB ASSEMBLIES

Application / Design Options

GLENAIR
QwikConnect

FLEX, RIGID-FLEX, AND PCBA CONNECTOR TERMINATION OPTIONS

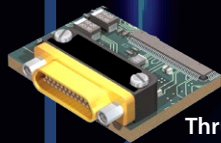

Thru-hole



Surface mount



Pogo pin /
spring-loaded contacts

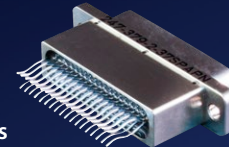

Straddle
mount



Compliant
pins



Direct
termination



Solder termination
with epoxy potting



ZIF (zero
insertion force)

FLEX AND RIGID-FLEX I/O CONNECTOR OPTIONS

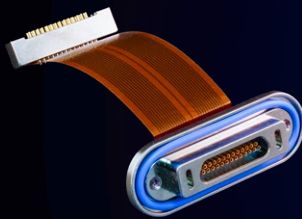

Environmentally sealed
rectangular I/O interface

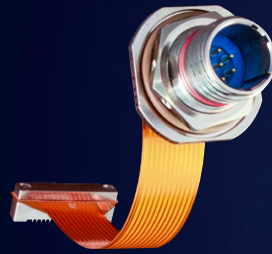

Military aerospace grade
circular: SuperNine D38999



Micro miniature aerospace-
grade circular: Mighty Mouse

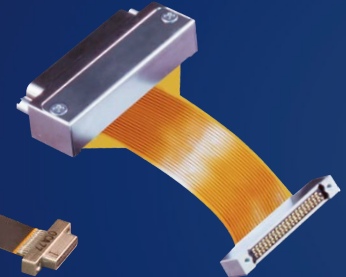

EMI shrouded precision-
machined M24308

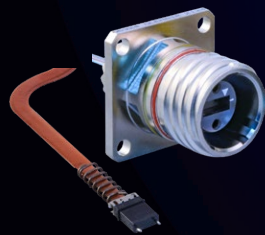

Ruggedized MT fiber optic
I/O circular

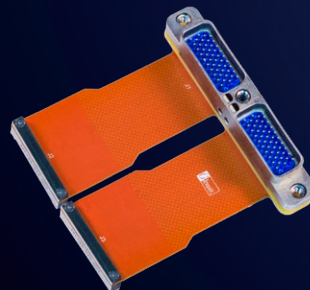

Dual-gang modular I/O:
Series 20 Super-Twin



Series 970 PowerTrip
power connector I/O



Micro miniature
push-pull QDC I/O

MULTILAYER AND DOUBLE-SIDED FLEX AND RIGID-FLEX DESIGN OPTIONS

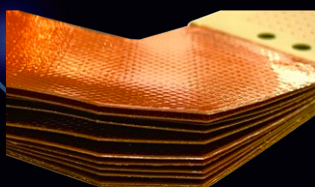

Multilayer rigid-flex circuit assemblies—up to 27 layers—offer increased circuit density while still maintaining the medium's dynamic 3D flex characteristics

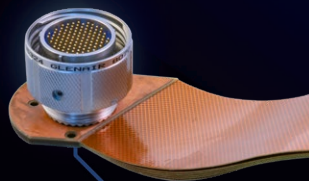

Double-sided flex circuits increase circuit density and power handling

TURNKEY FLEX, RIGID FLEX, AND PCB ASSEMBLIES

Production Lab

GLENDALE, CALIFORNIA
IPC 6012/6013 Class I, II, III, types 1-4
ISO 9001, AS9100 Certified

Glenair Integrated PCB/Flex assembly production facilities are operated in accordance with commercial and military standards. Staff includes 200+ PCB and cable assemblers with J-STD-001 Space certification for special processes and ESD management.

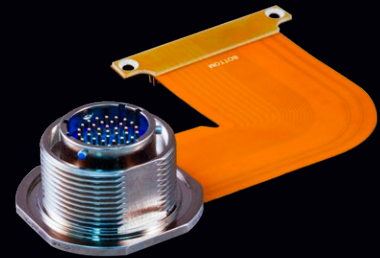

- High-availability catalog components as well as custom design and manufacture
- No minimums
- We never obsolete parts



Automated Optical Inspection and Flying Probe Electrical Test

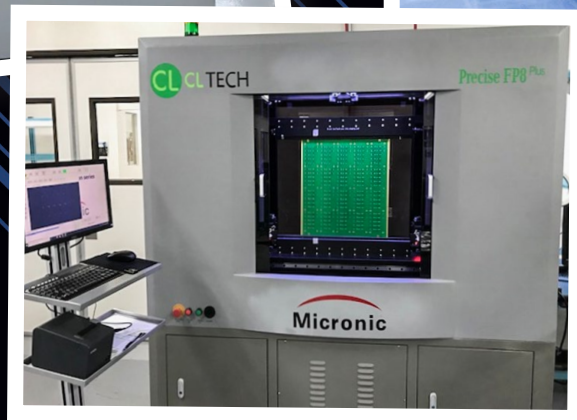



Glenair's PCB/Flex interconnect team is housed together under one roof. From electrical design to computer-aided manufacturing and assembly, the team has a well-deserved reputation for on-time delivery of even the most complex PCB/Flex assemblies.



BACKPLANE AND CARD-TO-CARD

Optical Flex Circuit Assemblies

TURNKEY, HIGH-DENSITY, MULTIMODE AND SINGLEMODE

SHUFFLE CIRCUITS AND OPTICAL FIBER CROSSOVER DESIGNS

High data rate **Optical** assemblies

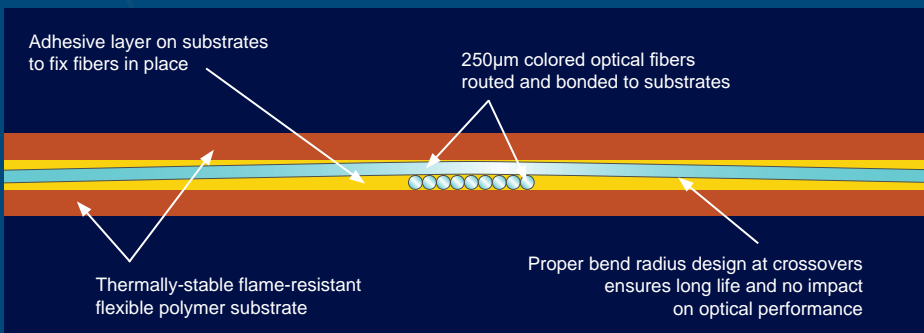
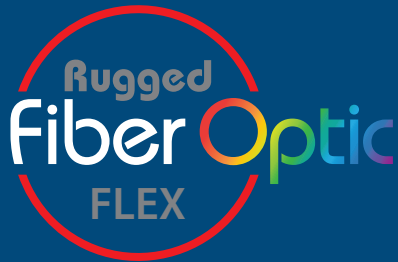

Cross-section of a two-layer optical flex circuit with crossover fibers

FEATURES

- Connectorized optical harness assemblies and breakouts, SM and MM
- Shuffle circuits with low-loss multimode fiber
- Ribbonized MT leads up to 12 inches and longer

BENEFITS

- Reduced installation / termination time and improved reliability
- Superior fiber management
- Complex fiber routing in minimal space
- Controlled routing lengths (low-skew)
- Controlled bend radius for minimized bend loss



3D layout and routing designs in Fusion 360

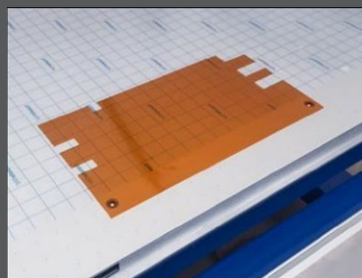

Build-to-print per customer specifications

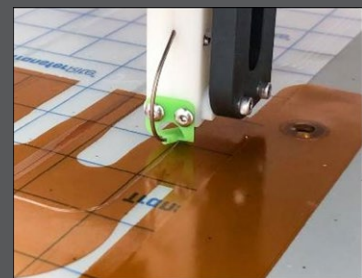

Single- and multimode fiber bonding

- Optical fiber bonded to a flame-resistant Kapton substrate—rad-hardened and outgassed assemblies available
- High-density fiber-to-fiber spacing: 250 µm
- Optimized fiber layouts, bend radius, and routing for high fiber-count applications
- Industry-standard connector terminations including FC, SC, LC, and others plus Glenair Signature F/O terminations including MT, GC, GHD, GFR, Eye-Beam, and others

Optical Fiber Nominal OD	250um
Fiber Types	Singlemode/Multimode
Operating Temperature	-40° to +100°C
Typical Minimum Bend Radii	0.5 inch
Circuit Thickness	.018 inch
Flat and 3D Designs	Yes
Flame Resistance	UL-V1 or Better
Shuffle Circuits	Yes
Substrate	Kapton

BACKPLANE AND CARD-TO-CARD

Optical Flex Circuit Assemblies

TURNKEY, HIGH-DENSITY, MULTIMODE AND SINGLEMODE

OPTICAL FLEX ECOSYSTEM

Integrated SM and MM Optical Flex assemblies

Ecosystem includes high-data-rate parallel optic transceivers, MTP®/MPO transceiver interface connectors, turnkey fiber optic breakout cables, and ruggedized MT ferrule-equipped I/O connectors—circular and rectangular.

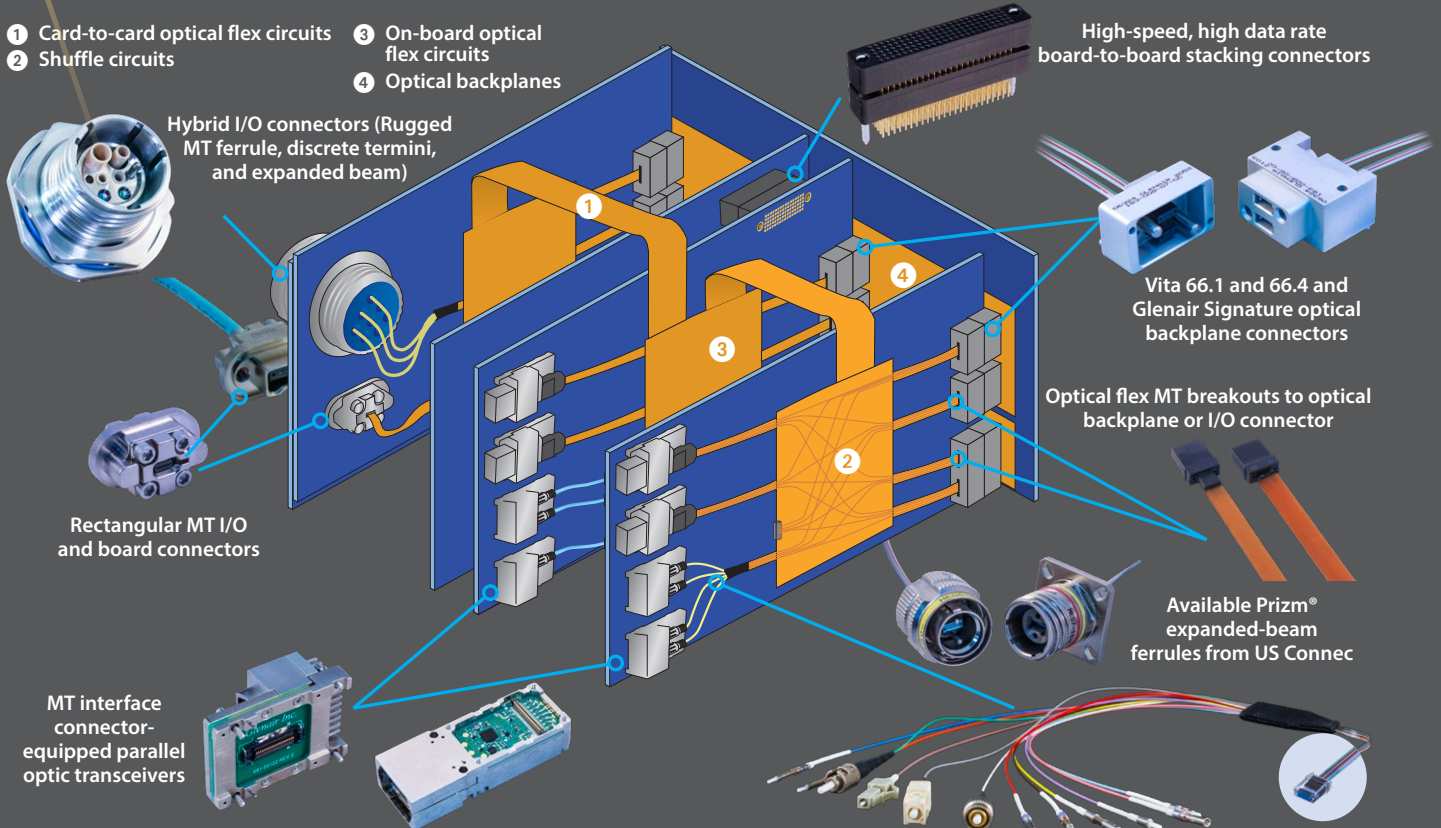

OPTICAL FLEX TRANSCEIVERS

High-Density MPO/MTP® Fiber Optic Interconnect

10 Gbps
PER CHANNEL

0500-3060 DataStar™ SPACE Quad Parallel F/O Transceiver



DataStar SPACE parallel optic transceiver modules with:

- Radiation lot acceptance testing (RLAT)
- Group C lot traceability
- ASTM E595 outgassing
- Heavy ion, gamma, proton radiation resistance

DataStar MIL-AERO parallel optic transceiver modules with:

- Aerospace-grade: -40°C to +100°C
- High-shock and vibration tolerant
- Secure PCB mounting and host board interconnection
- CDR (Clock Data Recovery) option available for 25Gbps and 28Gbps

28 Gbps
PER CHANNEL

0500-3023 DataStar™ MIL-AERO Quad Parallel F/O Transceiver

SPACE AND MIL-AERO GRADE MT Fiber Optic Connectors FOR USE WITH OPTICAL FLEX CIRCUITS



Up to 24 fibers in a single compact, lightweight ferrule



Ruggedized I/O connectors optimized for use with high-density MT ferrule optical flex

Mated pair of high-density Series 79 MT connectors—the smallest and lightest ruggedized MT assembly in the industry. Note the use of Optical Flex on the I/O receptacle side, and round environmental cable on the plug side

Lightweight, small form-factor MT fiber optics in Glenair Signature SuperNine[®] and Series 79 connectors: The aerospace-grade I/O connector solution for use with Glenair parallel optical transceivers and MT optical flex circuits

- Small form-factor, high-density MT fiber optic solutions for rugged space and mil-aero applications
- Optimized for use with parallel optic transceivers and optical flex circuitry
- Singlemode, multimode and specialty fiber including radiation-tolerant for space applications
- Temperature tolerance from -40°C to +85°C
- Designed for optimal low insertion loss performance in high vibration and shock environments
- IP67 Environmental sealing, IP68 available at interface

TWO STYLES OF HIGH-DENSITY MT FERRULES SUPPORTED: STANDARD MT PHYSICAL CONTACT FERRULE AND LOW-LOSS PRIZM[®] LENS EXPANDED BEAM



Both ferrule styles are easily inserted with common tools, and may be equipped with an engineered spring member for precise axial alignment in high vibration and shock applications.

SPACE AND MIL-AERO GRADE MT Fiber Optic Connectors FOR USE WITH OPTICAL FLEX CIRCUITS

CIRCULAR
AND RECTANGULAR

Ruggedized MT I/O Connectors



Plug with EMI/RFI ground spring
Shell size-insert arrangement
11-1, Up to 24 fibers
(1 MT ferrule)

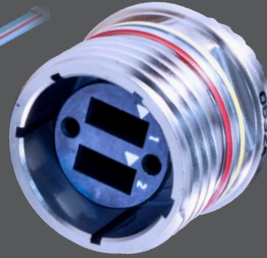

In-line receptacle
Shell size-insert arrangement
13-2, Up to 48 fibers
(2 MT ferrules)

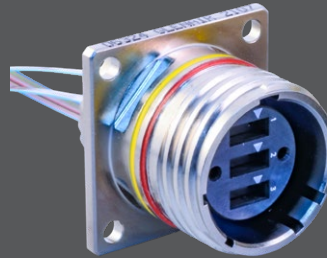

Panel-mount receptacle
Shell size-insert arrangement
15-3, Up to 72 fibers
(3 MT ferrules)

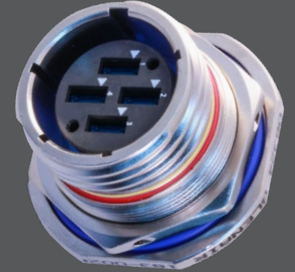

Jam nut receptacle
Shell size-insert arrangement
17-4, Up to 96 fibers
(4 MT ferrules)



Single-ferrule MT
Series 79 plug
up to 24 fibers



Single-ferrule MT
Series 79 receptacle
up to 24 fibers



Dual-ferrule MT
Series 79 plug
up to 48 fibers

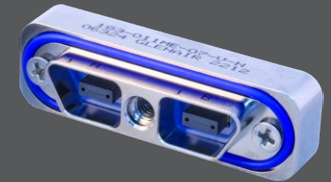

Dual-ferrule MT
Series 79 receptacle
up to 48 fibers

VITA 66.1 AND 66.4 MT FERRULE RUGGED OPTICAL BACKPLANE CONNECTORS FOR VPX BACKPLANE APPLICATIONS

Right-angle configurations for motherboard to daughtercard applications

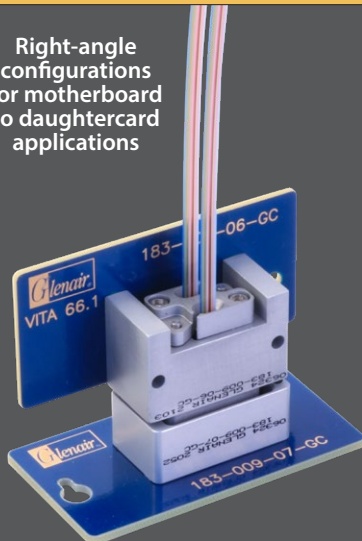

- VITA 66.1 and 66.4 spec compliant for use with optical backplanes
- Integrated alignment pins
- Glenair designed spring-loaded MT ferrules
- Supports industry standard MT ferrules—up to 24 channels per MT
- No unique tooling required for assembly

IDEALLY SUITED FOR

- Embedded computing devices
- Military aircraft (Phased Array) Radars
- Flight computers and other aircraft LRUs
- Command center comms equipment

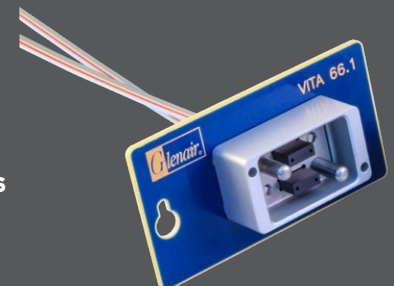

FLEX, RIGID FLEX, AND RIGID PCB ASSEMBLIES

Rectangular PC-Tail Connectors

SHORT LEAD-TIME, IN-HOUSE MANUFACTURED

SERIES 28 HIPER-D M24308 HIGH-PERFORMANCE ENVIRONMENTAL PCB CONNECTORS



280-022
straight PC tail
pin connector



280-023
straight PC tail
socket connector

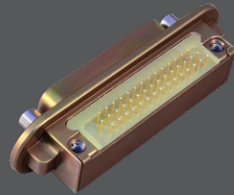

280-024
right-angle PC tail
pin connector

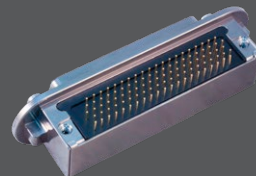

280-025
right-angle PC tail
socket connector

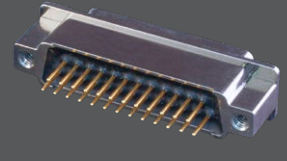

280-026
straight PC tail
pin connector, low-profile

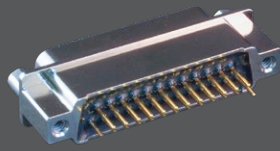

280-027
straight PC tail
socket connector, low-profile



280-028
right-angle PC tail
pin connector, low-profile



280-029
right-angle PC tail
socket connector, low-profile



280-050
combo straight PC tail
pin connector



280-051
combo straight PC tail
socket connector



280-052
combo right-angle PC tail
pin connector



280-053
combo right-angle PC tail
socket connector



280-054
combo straight PC tail
pin connector, low-profile



280-055
combo straight PC tail
socket connector, low-profile



280-056
combo right-angle PC tail
pin connector, low-profile

SERIES 79 HIGH-PERFORMANCE MICRO-CRIMP ENVIRONMENTAL PCB CONNECTORS

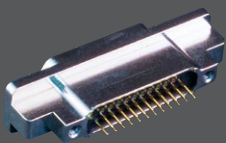

790-028
straight PC tail
panel receptacle

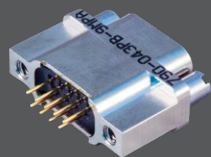

790-043
straight PC tail
free-standing receptacle

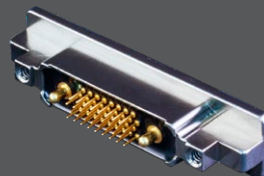

790-029
straight PC tail
panel plug



790-044
straight PC tail
free-standing plug



790-042
Right angle PCB
panel-mount hybrid coax

FLEX, RIGID FLEX, AND RIGID PCB ASSEMBLIES

GLENAIR
QwikConnect

Rectangular PC-Tail Connectors

SHORT LEAD-TIME, IN-HOUSE MANUFACTURED

ALPHALINK • SERIES 791 • SERIES 792 HIGH-PERFORMANCE RECTANGULAR PCB ENVIRONMENTAL CONNECTORS

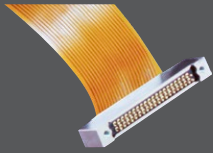

171-134
AlphaLink SL connector with
spring-loaded contacts

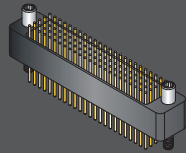

GSTT-PF
HD Stacker
top-of-stack flex

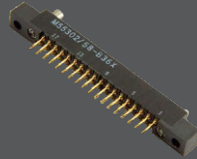

GTBA/GTBB-SF
MIL-DTL-55302 type
flex vertical PCB



791-015/-011
Series 791 straight and 90°
scoop-proof panel-mount
with grounding fingers

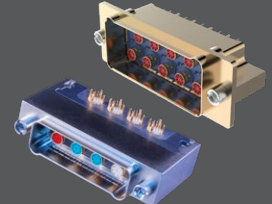

792-006/-010
Series 792 Straight and 90°
high-speed El Ochito

MIL-DTL-83513 MICRO-D AND HIGH-SPEED MICRO-D ENVIRONMENTAL PCB CONNECTORS

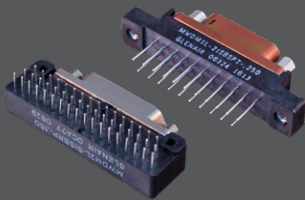

MWDM-B
MWDM-BR
vertical and 90° mount
thru-hole PCB

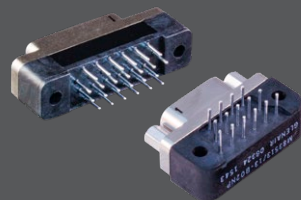

MWDM-CBS
MWDM-CBR
vertical and 90° mount
thru-hole condensed PCB

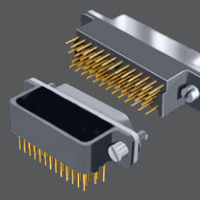

GMR75
GMR75C
Condensed board, .075" pitch
vertical and 90° PCB

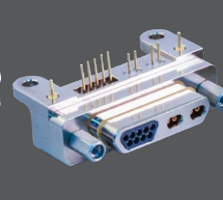

GHS4-M
VersaLink
high-speed Micro-D
right angle PCB

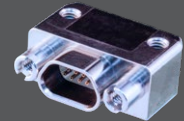

GHSM-HBR
High-Speed Micro-D
right angle PCB

MIL-DTL-32139 NANOMINIATURE AND GMMD ENVIRONMENTAL PCB CONNECTORS

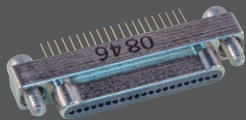

890-006/-007
single-row vertical PCB
plugs / receptacles

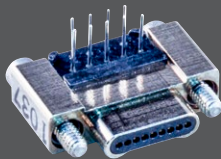

890-008/-009
single-row right angle PCB
plugs / receptacles



891-006/-007
dual-row vertical PCB
plugs / receptacles

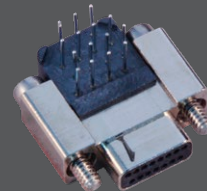

891-008/-009
dual-row right angle PCB
plugs / receptacles

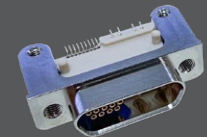

GMMD
high-speed micro with nano
TwistPin contacts

HERMETIC RECTANGULAR GLASS-TO-METAL SEAL PCB CONNECTORS



790-066
Series 79
hermetic PCB connectors

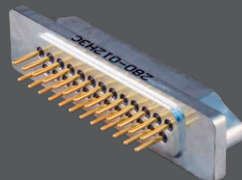

280-012H
HiPer-D
hermetic PCB connectors



177-140H
Micro-D solder-mount
hermetic PCB connectors



177-705H
Micro-D rear panel-mount
hermetic PCB connectors

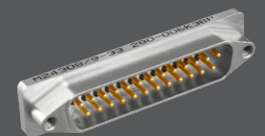

QPL-M24308/9
D-Subminiature straight
thru-hole PCB hermetic

FLEX, RIGID FLEX, AND RIGID PCB ASSEMBLIES

Circular PC-Tail Connectors

SHORT LEAD-TIME, IN-HOUSE MANUFACTURED

SUPERNINE® D38999 SERIES III ENVIRONMENTAL PCB CONNECTORS



233-207
flush-flange receptacle



233-208
stepped contact receptacle



233-209
short standoff receptacle

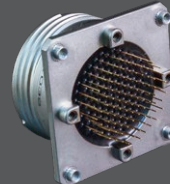

233-210
threaded standoff receptacle



233-211
dual flange receptacle

SUPERNINE® D38999 SERIES III ENVIRONMENTAL PCB SPECIALS

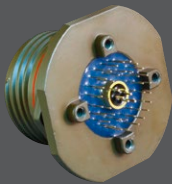

233-218
high-speed hybrid
with threaded standoffs



233-217
high-speed jam nut
with El Ochito® contacts

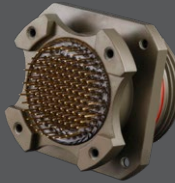

240-383D
dual-flange wall-mount
EMI filter connector

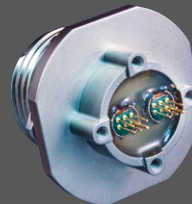

050-335
opto-electronic jam nut
with threaded standoff



257-859
PCB receptacle with
compliant pin contacts

SUPERNINE® D38999 SERIES III GLASS- AND LIGHTWEIGHT ENCAPSULANT-SEALED PCB HERMETICS

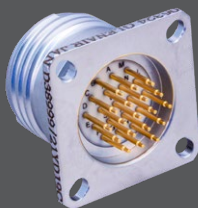

233-100-H2
box mount receptacle



233-100-H5
solder mount receptacle

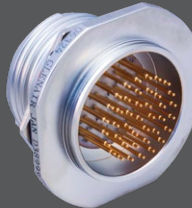

233-100-H7
jam nut mount receptacle

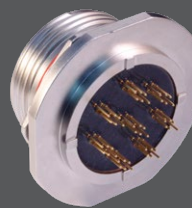

233-254
high-speed hermetic
jam nut receptacle

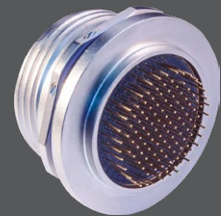

233-250
CODE-RED lightweight
hermetic jam nut receptacle

MIL-DTL-38999 SERIES I, II, III, AND IV QPL GLASS-SEALED PCB CONNECTORS—CLASS N, Y, AND H (SPACE-GRADE) HERMETIC

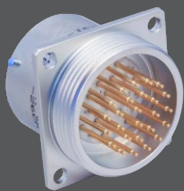

231-100-H0, H7, H5
Series I scoop-proof bayonet

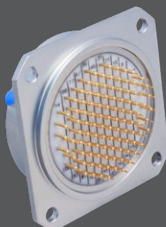

232-100-H0, H2, H5, H7
Series II low-profile bayonet



233-100-H2, -H5, -H7, -H8
Series III triple-start



234-100-H2, H7, H5, H8
Series IV scoop-proof breech-lock

FLEX, RIGID FLEX, AND RIGID PCB ASSEMBLIES

Circular PC-Tail Connectors

SHORT LEAD-TIME, IN-HOUSE MANUFACTURED

SERIES 80 MIGHTY MOUSE MICRO MINIATURE ENVIRONMENTAL PCB CONNECTORS



Series-800
UN thread



Series-801
double-start thread



Series-803
bayonet-lock



Series-804
push-pull QDC



Series-805
triple-start

SERIES 88 SUPERFLY AND M32139-TYPE NANOMINIATURE CIRCULAR ENVIRONMENTAL PCB CONNECTORS

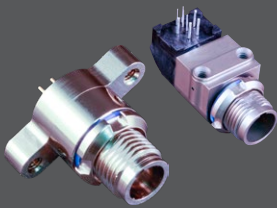

SuperFly
880-041R--880-037R
QDC vertical and 90° receptacle



SuperFly
881-019R--881-020R
threaded vertical and 90° receptacle



Nanominiature
893-008--893-009
breakaway and threaded straight

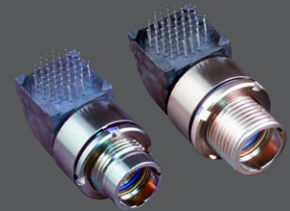

Nanominiature
893-010--893-011
breakaway and threaded right-angle

SERIES 806 MIL-AERO MICRO MINIATURE ENVIRONMENTAL PCB CONNECTORS



806-021--806-022
Environmental

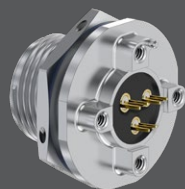

806-058
High-frequency coax

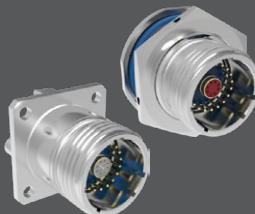

806-039--806-040
High-speed El Ochito



240-806-21
EMI/RFI filter



806-025, -026 glass
806-028, -043 lightweight
Hermetic

SUPERSEAL RJ45 / USB ENVIRONMENTAL PCB CONNECTORS



MIL-DTL-38999 Sr. III
SuperSeal



Series-80 Mighty Mouse
SuperSeal



Series-IPT 26482 type
SuperSeal



Series-ITS 5015 type
SuperSeal



MIL-DTL-28840
SuperSeal

POINT-TO-POINT

AlphaLink[®] SL Flex Jumpers

RUGGED I/O TO SPRING-PIN CONTACT FLEX ASSEMBLIES



AlphaLink[®] SL flex jumpers: Compact point-to-point assemblies that combine lightweight flex circuitry with Glenair signature I/O and board-level connectors. These turnkey jumper assemblies reduce system size and weight while accelerating assembly qualification and test of aerospace avionics and other mission-critical electronic systems.

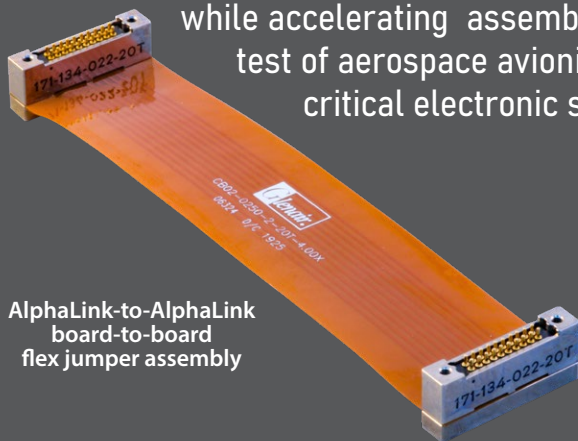

AlphaLink-to-AlphaLink
board-to-board
flex jumper assembly

A high-availability, fast-turnaround catalog solution, Glenair AlphaLink flex jumpers offer superior electrical and mechanical performance compared to conventional wire harnessing

- Chemically etched, copper-clad polyimide flex circuit jumpers offer excellent temperature tolerance, dimensional stability, and reduced size and weight
- All designs utilize AlphaLink[®]SL board connectors with solder-free spring-loaded contacts
- Glenair small form-factor Mighty Mouse, Micro-Crimp, HiPer-D, and SuperFly I/O connectors
- Designed for optimal electrical performance, including matched-impedance applications

POINT-TO-POINT

AlphaLink® SL Flex Jumpers

RUGGED I/O TO SPRING-PIN CONTACT FLEX ASSEMBLIES

POINT-TO-POINT JUMPER
SELECTION GUIDE

AlphaLink® SL Solder-Free I/O-to-Board



Series 89 Circular Nanominiature-to-AlphaLink SL flex jumper with breakaway or threaded I/O coupling in 6 contact arrangements



Series 88 SuperFly-to-AlphaLink SL flex jumper with quick-disconnect or threaded I/O coupling in 7 contact arrangements



Series 801 Mighty Mouse-to-AlphaLink SL flex jumper with double-start ACME thread I/O coupling in 8 contact arrangements



Series 804 Mighty Mouse-to-AlphaLink SL flex jumper with push-pull quick-disconnect QDC I/O coupling in 8 contact arrangements



Series 89 Rectangular Nanominiature-to-AlphaLink SL flex jumper (rear-panel-mount plug or receptacle) in 7 contact arrangements

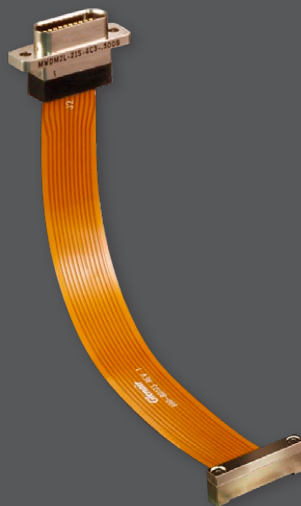

High-reliability Micro-D MIL-DTL-83513 type rectangular-to-AlphaLink SL flex jumper in 7 contact arrangements

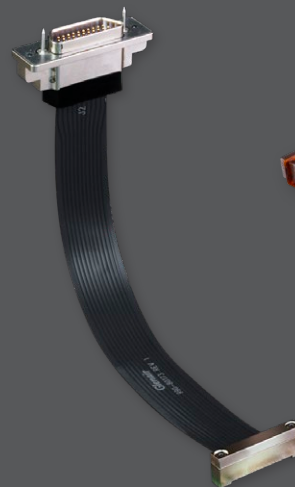

Series 79 Micro-Crimp advanced-performance rectangular-to-AlphaLink SL flex jumper in 7 contact arrangements

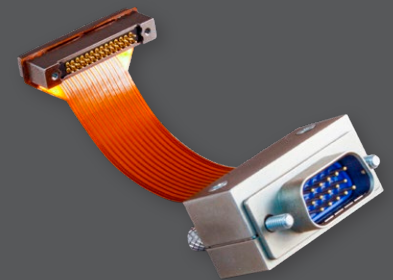

Series 28 HiPer-D -to-AlphaLink SL flex jumper (MIL-DTL-24308 intermateable rectangular) in 6 contact arrangements

Outlook

Force Multiplier

This past week, we hosted a big group at the factory from our field sales force in Europe. In addition to their classroom activities—mostly new product training and Glenair culture sessions—the team enjoyed touring our Southern California factories in Glendale, Arcadia, and Anaheim, as well as face-time with product managers, engineers, and members of the operations team. For most of the group, this was their first opportunity to visit the Glenair headquarters in over two years. During that time, we hosted numerous broadcast and on-line activities from our Glenair TV Studios—the in-house platform we use for monthly updates to the sales team and others. But as many of us observed this past week, there is no substitute for bringing the team to the factory.

There is a great deal of mutual respect between our field sales force and the factory team, as both ends of the bench understand the value that the other side brings to the table. And I must say, one of the key ways we maintain this value at Glenair is through regularly scheduled training sessions that expose our field sales force to the people and culture of the factory. There is an old saw about the sibling wine-makers Ernest and Julio Gallo, and the friendly spirit of competition between them. Ernest managed the sales side of the business and reportedly liked to say that his goal was to sell more wine than Julio could make. While Julio countered it was his goal to make more wine than Ernest could sell.

We have a bit of this same approach at Glenair, and we do our best to ensure each side in the friendly competition has all the resources needed to meet their responsibilities to keep their area of operation healthy and going strong. This next observation may get into the metaphysical weeds a bit, but I do believe it is true and worth sharing. And that is that this business of bringing the sales force to the factory—in this case all the way from Europe—has the mysterious effect of multiplying their numbers. What do I mean by this? Merely that the size of the force that sits down on day one of the training seems to miraculously expand by the end of the week.

We are all familiar with the concept of a force multiplier. A long lever arm for example, leveraged against a fulcrum, provides an individual with the ability to lift a far heavier load than would otherwise be possible. In military applications, a force multiplier is an advantage—such as provided by advanced weaponry—that gives the unit the ability to accomplish far greater feats than would be possible without it. The Glenair STAR-PAN power and data hub is a classic example of a force multiplier, as it allows the guys on the ground to tackle longer missions, with greater safety and mission effectiveness. In other words, it multiplies their force, as if their very numbers were greater.

We see the same thing happen when members of the sales team visit the factory. All the knowledge, skills, and company culture they obtain in the process literally multiplies their effectiveness in the field and their ability to provide value and service to our customers. Glenair is committed to knowledge, skills, and affective domain training and development. We believe it is one of the key ways we ensure our organization is well positioned to meet the complex challenges of our mission-critical interconnect business.

Chris Toomey

QwikConnect

GLENAIR • Volume 26 • Number 3

Publisher

Christopher J. Toomey

Managing Editor

Marcus Kaufman

Art Director/Editor

Mike Borgsdorf

Graphic Designer

George Ramirez

Editor

Meghan Taylor

Technical Consultant

Jim Donaldson

Issue Contributors

Scott Meloche

Indy Murillo

Mathias Natakui

Greg Noll

Tom Pflingston

Ben Porcaro

Chris Van Soest

Distribution

Terry White

*To subscribe or unsubscribe,
please contact Terry White:
twhite@glenair.com*

QwikConnect is published quarterly by Glenair, Inc. and printed in the U.S.A. All rights reserved. © Copyright 2022 Glenair, Inc. A complete archive of past issues of QwikConnect is available on the Internet at www.glenair.com/qwikconnect

GLENAIR, INC.

1211 AIR WAY
GLENDALE, CA 91201-2497
TEL: 818-247-6000
FAX: 818-500-9912
E-MAIL: sales@glenair.com
www.glenair.com

