



BATTLE-TESTED

STAR-PAN™

Soft Goods: Mission Kit Bag and Pouches, MOLLE Pouches, and Connector Dust Caps

SOFT GOODS: MISSION KIT BAG AND POUCHES

Part No.	Description	Weight	Length	Material/Color	ECCN / EAR	Page No.
TS4-011	Mission Kit Bag with Pouches - Complete Kit	2.08 lbs.	L = 20" W = 14" D = 2.5" (outer Kit Bag)	Cordura/Black	99	163
TS4-001	Mission Kit Bag	.9 lbs	L = 20" W = 14" D = 2.5"	Cordura/Black	99	163
TS4-002	Large Pouch	.18 lbs.	W = 18" H = 4"	Cordura/Black	99	164
TS4-003	Square Pouch	.9 lbs.	W = 10" H = 10"	Cordura/Black	99	164
TS4-004	Medium Pouch	.1 lbs.	W = 9.5" H = 5"	Cordura/Black	99	164
TS4-017	STAR-PAN II MOLLE Pouch	1.1 oz.	L = 3.5" W = 2.5" H = 1"	Cordura/Desert Tan or Camouflage	99	165
TS4-018	STAR-PAN IV MOLLE Pouch	(consult factory)	(consult factory)	Cordura/Desert Tan or Camouflage	99	165
TS4-009	STAR-PAN VI MOLLE Pouch	4 oz.	L = 5" W = 7" H = 1.5"	Cordura/Desert Tan or Camouflage	99	165
TS4-028	MISSION MANAGER MOLLE Pouch	(consult factory)	L = 4" W = 2"	Cordura/Desert Tan or Camouflage	99	165
TS4-022	Connector dust caps	(consult factory)	various	Tan or Black	99	166
TS4-024	Dust Caps for in-line cable receptacles	(consult factory)	various	Tan or Black	99	167
TS4-025	Dust Caps for in-line cable plugs	(consult factory)	various	Tan or Black	99	167

BATTLE-TESTED

STAR-PAN™

Soft Goods: Mission Kit Bag and Pouches



SOFT GOODS



MISSION KIT BAG SPECIFICATIONS

- Designed to store, organize, and transport all components of the Glenair STAR-PAN system: hubs, cables, adapters, and accessories
- Lightweight, yet rugged and durable
- Black Cordura / nylon mesh construction
- Paracord zipper pulls
- Mission Bag is MOLLE-compatible
- Pouches are user-configurable with secure Velcro attachment to Mission Bag
- Order Bag and Pouches separately, or as a kit



QUALIFIED FOR USE WITH
ALL STAR-PAN POWER / DATA HUBS:
LIGHT, I, II, IV, AND VI

HOW TO ORDER

Sample Part Number: TS4-011	
Soft Goods	Mission Kit Bag with Pouches - Complete Kit
Kit Contents	TS4-001 – Mission Bag (qty. 1) TS4-002 – Large Pouch (qty. 3) TS4-003 – Square Pouch (qty. 2) TS4-004 – Medium Pouch (qty. 2)



Front view



Back view

MISSION KIT BAG SPECIFICATIONS

- Designed to store, organize, and transport all components of the Glenair STAR-PAN system: hubs, cables, adapters, and accessories
- Black Cordura construction
- Molle web on front of bag
- Front loop Velcro for patches
- Full loop fabric fastening interior for modularity and organization
- Rear pocket for additional storage
- Grab Handles
- Paracord zipper pulls
- Length = 20" Width = 14" Depth = 2.5" Weight = .9 lbs.

HOW TO ORDER

Sample Part Number: TS4-001	
Soft Goods	Mission Kit Bag

BATTLE-TESTED

STAR-PAN™

Soft Goods: Mission Kit Bag and Pouches



SOFT GOODS

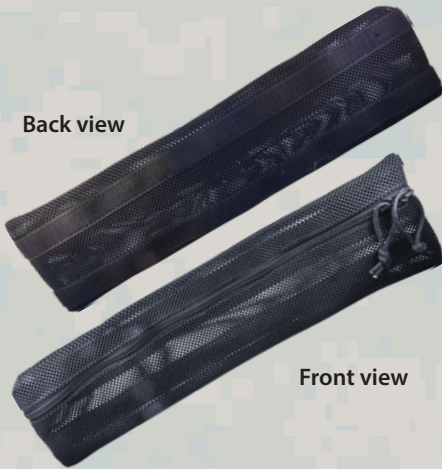

STAR-PAN II HUB AND CABLE POUCH SPECIFICATIONS

- Designed to hold STAR-PAN II Power/Data Hubs or STAR-PAN system cables inside the Glenair STAR-PAN Mission Kit Bag
- Black Cordura mesh construction for quick visual reference of contents
- Dual rear Velcro hook strips
- Paracord zipper pulls
- Width = 18" Height = 4" Weight = .18 lbs.

HOW TO ORDER

Sample Part Number:	TS4-002
Soft Goods	Pouch, large



STAR-PAN IV / VI HUB SQUARE POUCH SPECIFICATIONS

- Designed to hold STAR-PAN IV / VI hubs inside the Mission Kit Bag
- Black Cordura mesh construction for quick visual reference of contents
- Dual rear Velcro hook strips
- Paracord zipper pulls
- Width = 10" Height = 10" Weight = .9 lbs.

HOW TO ORDER

Sample Part Number:	TS4-003
Soft Goods	Pouch, square



ADAPTER / NON-CABLED ITEM POUCH SPECIFICATIONS

- Designed for use inside the Glenair STAR-PAN Mission Kit Bag
- Black Cordura mesh construction for quick visual reference of contents
- Dual rear Velcro hook strips
- Paracord zipper pulls
- Width = 9.5" Height = 5" Weight = .1 lbs.

HOW TO ORDER

Sample Part Number:	TS4-004
Soft Goods	Pouch, medium

BATTLE-TESTED

STAR-PAN™

Soft Goods: MOLLE pouches



SOFT GOODS



STAR-PAN II MOLLE pouch

STAR-PAN II MOLLE POUCH SPECIFICATIONS

- Tan or Camouflage Cordura
- Single-button snap-lock for mounting on MOLLE loops
- Front loop Velcro securely retains STAR-PAN II hub

HOW TO ORDER

Sample Part Number:		TS4-017	-T
STAR-PAN MOLLE Pouch	STAR-PAN II MOLLE pouch		
Color Option	-T = Tan -C = Camo		



STAR-PAN IV MOLLE pouch

STAR-PAN IV MOLLE POUCH SPECIFICATIONS

- Tan or Camouflage Cordura
- Single-button snap-lock for mounting on MOLLE loops
- Front loop Velcro securely retains STAR-PAN IV hub

HOW TO ORDER

Sample Part Number:		TS4-018	-T
STAR-PAN MOLLE Pouch	STAR-PAN IV MOLLE pouch		
Color Option	-T = Tan -C = Camo		



STAR-PAN VI MOLLE pouch

STAR-PAN VI MOLLE POUCH SPECIFICATIONS

- Tan or Camouflage Cordura
- Single-button snap-lock for mounting on MOLLE loops
- Front loop Velcro securely retains STAR-PAN II hub

HOW TO ORDER

Sample Part Number:		TS4-009	-C
STAR-PAN MOLLE Pouch	STAR-PAN VI MOLLE pouch		
Color Option	-T = Tan -C = Camo		



MISSION MANAGER MOLLE pouch

MISSION MANAGER MOLLE POUCH SPECIFICATIONS

- Tan or Camouflage Cordura
- Single-button snap-lock for mounting on MOLLE loops
- Front loop Velcro securely retains MISSION MANAGER

HOW TO ORDER

Sample Part Number:		TS4-028	-T
STAR-PAN MOLLE Pouch	STAR-PAN II MOLLE pouch		
Color Option	-T = Tan -C = Camo		

BATTLE-TESTED

STAR-PAN™

Soft Goods: Dust Caps



SOFT GOODS

SPECIFICATIONS

- Rugged and reliable environmental protection for Mighty Mouse 807 series size 6 connectors provided on STAR-PAN system hubs and cables
- Santoprene material
- Plug and receptacle designs
- Self-retaining and zip tie styles
- Black or tan color

HOW TO ORDER

Sample Part Number:	TS4-022	-3	-T
STAR-PAN Connector Dust Cap	STAR-PAN system connector dust caps		
Configuration	-3, -4, -5, -6 (see diagrams)		
Color Option	-T = Tan Omit = Black		



QUALIFIED FOR USE WITH ALL STAR-PAN POWER / DATA HUBS
LIGHT, II, IV, AND VI

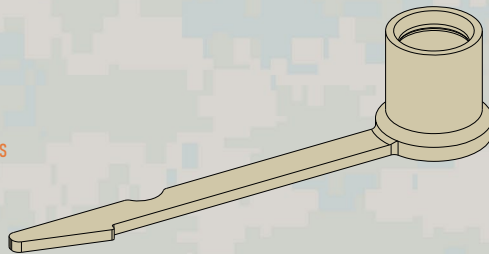

-3 for size 6 plug,
zip tie loop, 1.60" length

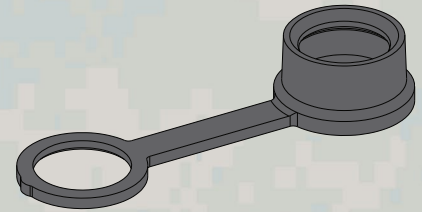

-4 for size 6 receptacle,
self-retaining, external sealing

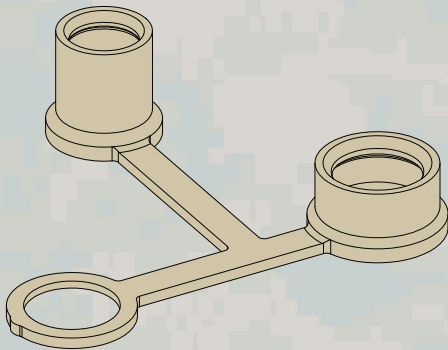

-5 size 6 receptacle and plug,
self-retaining, external sealing

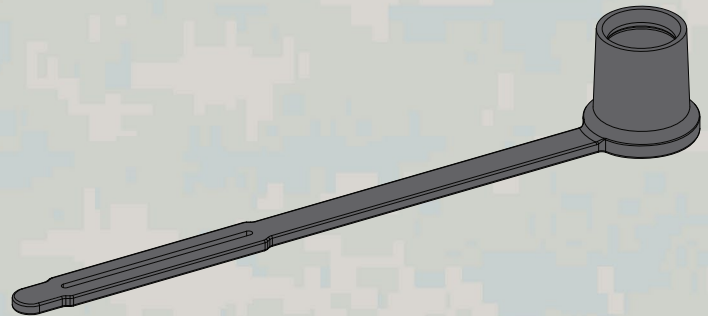

-6 for size 6 plug,
zip tie loop, 2.25" length

BATTLE-TESTED

STAR-PAN™

Soft Goods: Dust Caps



SOFT GOODS

HOW TO ORDER

Sample Part Number:	TS4-024	-T
STAR-PAN Connector Dust Cap	STAR-PAN system receptacle dust cap for in-line cable receptacle connectors	
Color Option	-T = Tan Omit = Black	

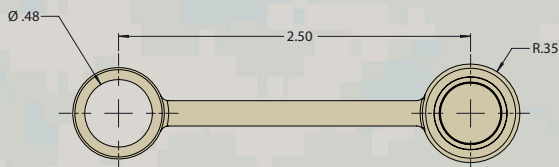
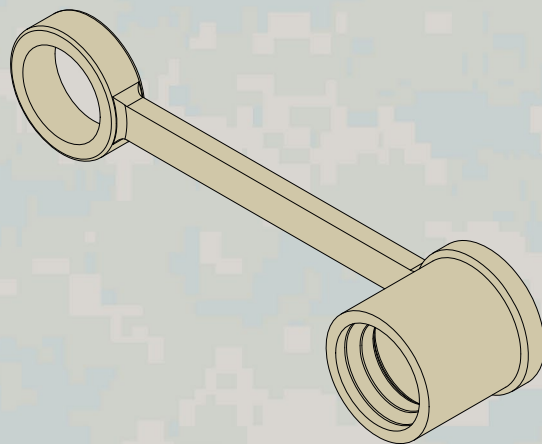

QUALIFIED FOR USE WITH ALL STAR-PAN POWER / DATA HUBS
LIGHT, II, IV, AND VI

HOW TO ORDER

Sample Part Number:	TS4-025	-T
STAR-PAN Connector Dust Cap	STAR-PAN system receptacle dust cap for in-line cable plug connectors	
Color Option	-T = Tan Omit = Black	

